

M

A

K



A Lifestyle  
Collection



## Jazi Gloss Painted

Featured colour: Metallic Champagne  
taken from the Gloss Colour Studio.

Welcome to 'A Lifestyle Collection' – our comprehensive catalogue which showcases the full range of products offered by MAK Distribution Ltd.

We pride ourselves on our excellent reputation for providing top quality products and excellent customer service. We are completely dedicated to total customer satisfaction and our enthusiastic service team are always happy to help.

With a wealth of experience and knowledge we are recognised as one of the UK's leading distributors of kitchen components supplying the UK Kitchen trade.

MAK Distribution is ideally placed in a central distribution network with close links to major motorways. We offer nationwide delivery to your specified address. Alternatively you can call and collect and whilst here meet the team and have a look at our showroom and presentation area showcasing our kitchen ranges.

- Close to M18 Junction 4 (2 miles)
- Robin Hood Airport (11 miles)
- Doncaster Train Station (4 miles).

#### MAK Distribution Ltd

Units 3-6 Century Close, Kirk Sandall Industrial Estate, Doncaster, South Yorkshire, DN3 1TR

T: 01302 888744 F: 01302 888687 E: sales@makdistribution.co.uk [www.makdistribution.co.uk](http://www.makdistribution.co.uk)





# Customer Services

MAK Distribution offers a personal and friendly service. Our aim is to enable our customers to be able to place their orders with ease. Our products are sourced from some of the world's best suppliers and held in stock here in Doncaster.

Our customer services is open:

8.30am to 5pm, Monday – Friday.

Orders can be placed via:

Phone: 01302 888744

Fax: 01302 888687

Email: [sales@makdistribution.co.uk](mailto:sales@makdistribution.co.uk)

Or via the website with our new online ordering system.

Connect with us:



## CD image library

All our images are available to order on a CD. Please contact customer services.

## Brochures

“A Lifestyle Collection” comes in two different formats to enable selling our products easier for you.



A catalogue specifically designed for **Trade Only.**

A brochure specifically designed for **Retail Only.**



## Email Newsletter:

Our email newsletters keep you fully informed of all our latest products, offers and promotions.

To receive our newsletter please contact customer services on:

**01302 888744**



# Online Services – visit us @ [www.makdistribution.co.uk](http://www.makdistribution.co.uk)

Browse the website to find all the components you require to design and build your perfect kitchen for your customers. Specially designed to easily navigate around you will find everything you need, making ordering easy.

- All of our catalogues, brochures and newsletters are also available to download on the website.
- Our technical Guides offer detailed analysis of our core products available online.
- One touch online order system



## Ordering online with MAK is easy

With a few simple steps your order will be placed, confirmed and despatched with one touch!

- Log on to your account via the website [www.makdistribution.co.uk](http://www.makdistribution.co.uk)
- Place your order, advise delivery details
- Complete your order
- Stock will be instantly allocated and confirmation sent
- Goods will be despatched
- Review your account online: Print statements, Invoices and check account status

Please contact customer services on:

**01302 888744**

Coming Soon

# Index



## Doors 8-29

Door Collections at a Glance	8-9
Jazi	10-17
Urbani	18-19
Priory	20-21
Westwood	22-23
Gainsborough	24-25
Vermuyden	26-27
Glebe	28-29

## The Colour Studio 30-47

The Timber Colour Studio	32-37
The Matt Colour Studio	38-41
The Gloss Colour Studio	42-47

## Worktops 48-65

Granite Worktops	50-52
Quartz Worktops	53-55
Granite and Quartz Edge Profiles	56-57
Mistral Worktops	58-61
Timber Worktops	62-65

## ASTRACAST Sinks & Taps 66-87

Sink and Tap Packs	67
Stainless Steel Layon Sinks	68-71
Composite Sinks	72-73
Ceramic Layon Sinks	74-75
Stainless Steel Undermount Sinks	76-81
Ceramic Undermount Sinks	82-83
Taps	84-87

## Door Handles 88-91

## Accessories 92-97

## Signe Storage Solutions 98-117

## DOMUS Line – Lighting 118-141

## Carcases 142-145

## Hettich 146-150

## Misc Fitting 151-153

## Technical Information 154-163



# Door Collections at a Glance

Jazi Handleless. 22mm Lacquered.



Jazi Dakar  
Page 10



Jazi Anthracite  
Pages 11 and 17



Jazi Silver Grey  
Pages 12 and 17



Jazi Matt White  
Page 13

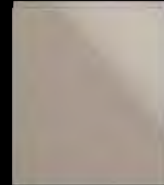

Jazi Stone  
Page 14



Jazi Gloss White  
Page 15



Jazi Ivory  
Page 16

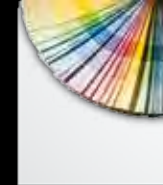

Jazi Paint  
to Order  
Pages 38 - 47

Urbani Gloss Slab. 18mm Lacquered.



Urbani White  
Page 18



Urbani Ivory  
Page 19



Urbani Dark Olive  
Page 19



Urbani Paint  
to Order  
Pages 38 - 47

Priory Shaker. 20mm Matt Foil.



Priory Alabaster  
Pages 20 - 21





# Door Collections at a Glance

Westwood. Solid Timber Shaker. 20mm.



Westwood Natural  
Page 22



Westwood Ivory  
Page 23



Westwood Sanded Ash



Westwood Sanded Oak



Westwood Paint to Order  
Pages 32 – 37

Gainsborough. Solid Timber In-Frame Effect. 20mm.



Gainsborough  
Alabaster  
Pages 24-25



Gainsborough  
Ash



Gainsborough  
Paint to Order  
Pages 32 – 37



Vermuyden Oak  
Page 26



Vermuyden Cream  
Page 27

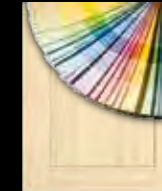

Vermuyden Paint to Order  
Pages 32 – 37

Glebe. Solid Timber Raised Centre Panel. 20mm.



Glebe Natural  
Page 28



Glebe Alabaster  
Page 29



Glebe Paint to Order  
Pages 32 – 37

# Door Collections – Jazi Handleless



Jazi Dakar

Jazi Dakar: Egger: U717 Dakar. Worktop: Light Mist. Lighting: Flexy CH.



## Jazi Anthracite

Jazi Anthracite: Egger: U961 Graphite grey.  
Worktop: Premium Black. Lighting: Metris.



## Jazi Silver Grey

Jazi Silver Grey: Kronospan: Chinchilla Grey UO197,  
Worktop: Bianco Polished. Lighting: Flexy LED.



## Jazi Matt White

Jazi White. Egger: W980 Platinum White  
Worktop: Premium Black Granite. Lighting: Metris.



Jazi larder door solution.



## Jazi Stone

Jazi Stone. Egger: U156 Sand Beige.  
Worktop Dark Mist Quartz. Lighting Metris.



## Jazi Gloss White

Jazi White. Egger: W980 Platinum White. Worktop: Nero Star. Lighting: Metris.



## Jazi Ivory

Jazi Ivory. Egger: U222 Crema.  
Worktop: Ivory White Fantasy. Lighting: Metris.





## Jazi Silver Grey and Anthracite

Jazi Silver Grey and Anthracite. Worktop: Bianco Polished. Lighting Metris.

# Urbani



## Urbani White

Urbani White. Egger: W980 Platinum White. Handles: TH226SS. Worktop: Premium Black. Lighting: Flexy LED. Plinth: Stainless Steel.



## Urbani Ivory

Urbani Ivory. Egger: U222 Crema. Worktop: European Walnut. Lighting: Metris.



## Urbani Dark Olive

Urbani Dark Olive. Egger: H3031 Dark Olive. Worktop: Bianco Polished. Lighting: Metris. Plinth: Stainless Steel.

# Priory Shaker



Priory Shaker. Egger: U104 Alabaster. Handles: 10265/160CR  
Worktop: Impala. Lighting: Giza.



Prory Shaker. Egger: U104 Alabaster. Handles: 10265/160CR.  
Worktop: Bianco Polished. Lighting: Giza.

# Westwood



Westwood Natural

Westwood Natural. Egger: H3368 Natural Lancaster Oak.  
Handles: 10082/192SS. Worktop: Verde Ubatuba. Lighting: Metris.



## Westwood Ivory

Westwood Ivory, Egger: U108 Vanilla. Handles: 60089/SS.  
Worktop: European Walnut. Lighting: Metris.

# Gainsborough



## Gainsborough Alabaster

Gainsborough Alabaster. Egger: U104 Alabaster.  
Handles: DN174IR. Worktop: Natural Oak. Lighting: Metris.





Vermuyden



Vermuyden Oak

Vermuyden Oak. Egger: H3368 Natural Lancaster Oak. Handles: DN174IR. Worktop: Nero Cosmos. Lighting: Metris.



## Vermuyden Cream

Vermuyden Cream. Egger: U108 Vanilla. Handles: CD176SS.  
Worktop: Full Stave Oak. Lighting: Metris.

Glebe



## Glebe Natural Oak

Glebe Natural Oak. Egger: H3368 Natural Lancaster Oak.  
Handles: CD176SS. Worktop: Star Galaxy. Lighting: Flexy CR.



## Glebe Alabaster

Glebe Alabaster. Egger U104 Alabaster. Handles: CD176SS.  
Worktop: Star Galaxy Granite. Lighting: Flexy LED.

A fan of color swatches is shown, fanned out from the top left towards the bottom right. The swatches are arranged in a grid pattern, with each swatch having a small white square in the bottom right corner. The colors transition from light yellows and greens on the left, through blues and purples in the middle, to reds, oranges, and yellows on the right. The fan is resting on a dark brown wooden surface with a visible grain.

## The Colour Studio

### 'Paint to Order'

With our bespoke colour palette we bring you a unique range that will complement any space. Add definition and character to allow more creativity in design and style.

All Timber and Matt Colour studio bespoke painted orders are on a 10 day lead time.

All Gloss bespoke painted orders are on a 4 week lead time.

## The Timber Colour Studio

Pages 32-37



## The Matt Colour Studio

Pages 38-41



## The Gloss Colour Studio

Pages 42-47



# The Timber Colour Studio

## Door options

Westwood  
Page 33

Gainsborough  
Pages 34-35

Glebe  
Page 36

Vermuyden  
Page 37

All Timber painted orders are on a 10 day lead time.

We are able to paint our Timber doors in any branded colour as a alternative option.



## Colour Collection

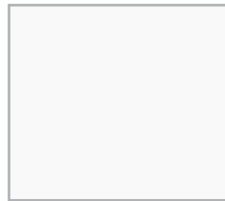

White

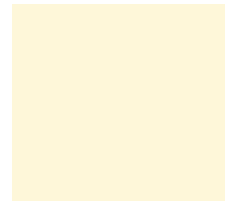

Alabaster



Sandstorm



Putty

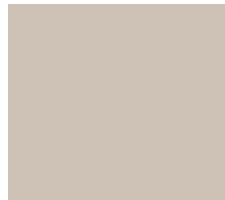

Portabella Stone



Dakar



Sage Green



Moss Green

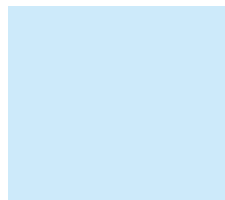

Periwinkle

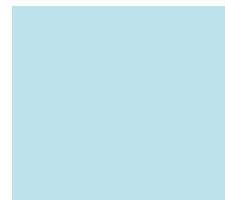

Vortex

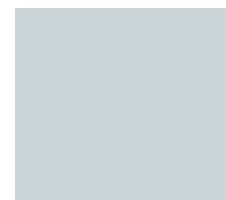

Alaska Blue



Blue Smoke

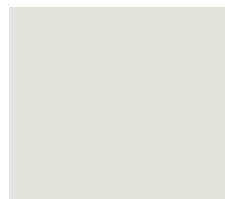

Ghost Grey



Lumina Grey



Carbonite

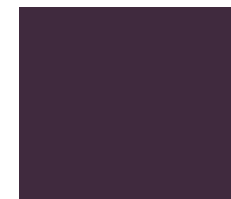

Aubergine

For technical reasons connected with colour reproduction, colours shown may not be an exact representation of the actual product. Please ask for a sample before ordering.





Westwood Timber Painted  
Featured colour: Portabella Stone taken  
from the Timber Colour Studio.



Westwood Timber Painted  
Featured colours: Carbonite and White  
taken from the Timber Colour Studio.



## Gainsborough Timber Painted

Featured colour: Sage Green taken from the Timber Colour Studio.



Gainsborough Timber Painted

Featured colour: Dakar taken from the Timber Colour Studio.



Glebe Timber Painted

Featured colour: Lumina Grey, Carbonite and White taken from the Timber Colour Studio.



## Vermuyden Timber Painted

Featured colours: Vortex and Oak combination  
taken from the Timber Colour Studio.

# The Matt Colour Studio

## Door options

Jazi  
Pages 39-40

Urbani  
Page 41

All Matt painted orders are on a 10 day lead time.

We are able to paint our Matt doors in any branded colour as a alternative option.

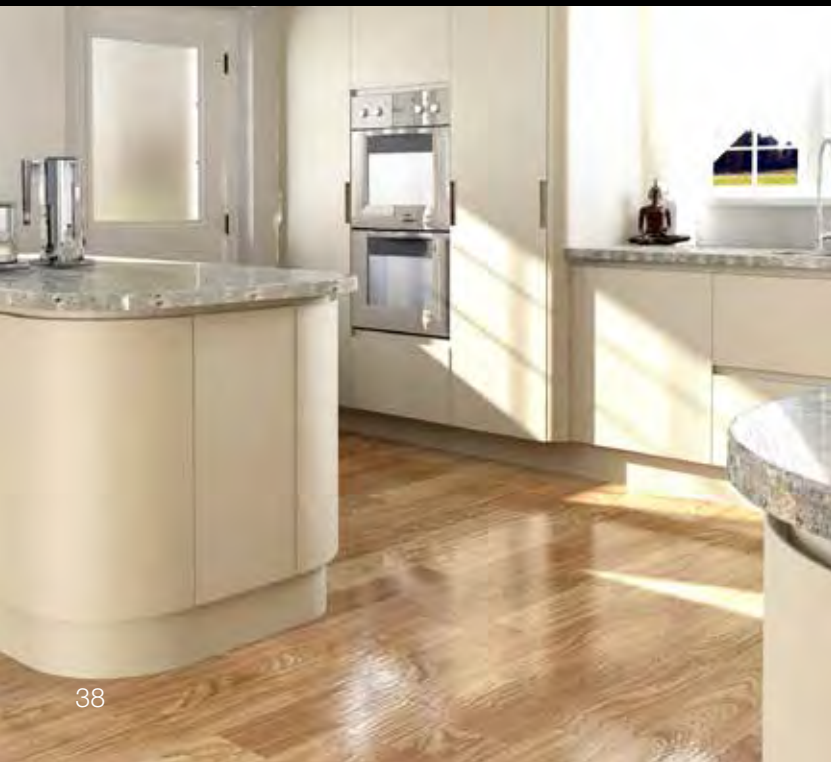

## Colour Collection

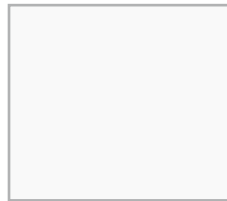

White

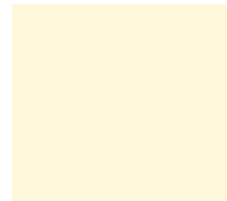

Alabaster



Sandstorm



Putty

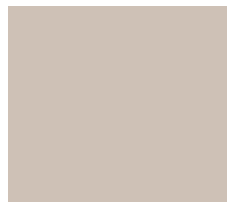

Portabella Stone



Dakar



Sage Green

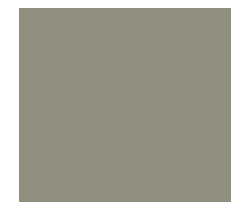

Moss Green

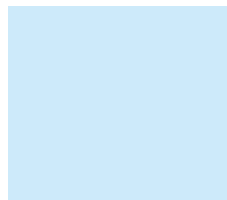

Periwinkle

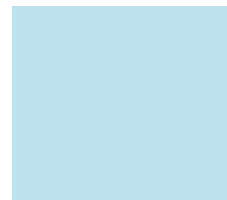

Vortex

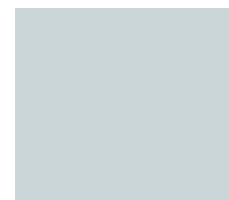

Alaska Blue



Blue Smoke

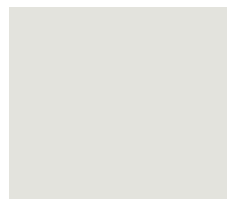

Ghost Grey



Lumina Grey



Carbonite

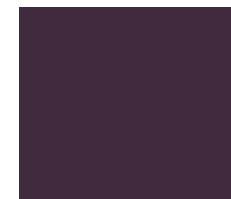

Aubergine

For technical reasons connected with colour reproduction, colours shown may not be an exact representation of the actual product. Please ask for a sample before ordering.



## Jazi Matt Painted

Featured colour: Periwinkle taken from the Matt Colour Studio.



## Jazi Matt Painted

Featured colour: Alabaster taken from the Matt Colour Studio.





## Urbani Matt Painted

Featured colour: Moss Green taken from the Matt Colour Studio.

# The Gloss Colour Studio

## Door options

Jazi  
Pages 43-45

Urbani  
Pages 46-47

All Gloss painted orders are on a 4 week lead time.

For technical reasons connected with colour reproduction, colours shown may not be an exact representation of the actual product. Please ask for a sample before ordering.



## Colour Collection



Gloss Alabaster  
Jazi Paint to Order  
Urbani Paint to Order



Stone  
Jazi Stocked  
Urbani Paint to Order



Dakar  
Jazi Stocked  
Urbani Paint to Order



Light Grey  
Jazi Paint to Order  
Urbani Paint to Order



Silver Grey  
Jazi Stocked  
Urbani Paint to Order



Anthracite  
Jazi Stocked  
Urbani Paint to Order



Black  
Jazi Paint to Order  
Urbani Paint to Order



Silver Metallic  
Jazi Paint to Order  
Urbani Paint to Order



Champagne Metallic  
Jazi Paint to Order  
Urbani Paint to Order



Copper Metallic  
Jazi Paint to Order  
Urbani Paint to Order



Antique Gold Metallic  
Jazi Paint to Order  
Urbani Paint to Order



Eastern Gold Metallic  
Jazi Paint to Order  
Urbani Paint to Order



Pink Sparkle Metallic  
Jazi Paint to Order  
Urbani Paint to Order



Red  
Jazi Paint to Order  
Urbani Paint to Order



Red Metallic  
Jazi Paint to Order  
Urbani Paint to Order



Aubergine  
Jazi Paint to Order  
Urbani Paint to Order



Aubergine Metallic  
Jazi Paint to Order  
Urbani Paint to Order

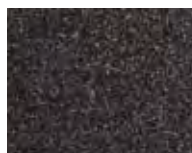

Rhodium Metallic  
Jazi Paint to Order  
Urbani Paint to Order



Galaxy Sparkle Metallic  
Jazi Paint to Order  
Urbani Paint to Order



Pink & Black Sparkle Metallic  
Jazi Paint to Order  
Urbani Paint to Order



Lime Metallic  
Jazi Paint to Order  
Urbani Paint to Order



Blue Metallic  
Jazi Paint to Order  
Urbani Paint to Order



## Jazi Gloss Painted

Featured colour: Aubergine taken from the Gloss Colour Studio.



## Jazi Gloss Painted

Featured colour: Light Grey taken from the Gloss Colour Studio.



## Jazi Gloss Painted

Featured colour: Pink Sparkle taken from the Gloss Colour Studio.



## Urbani Gloss Painted

Featured colour: Silver Grey taken from the Gloss Colour Studio.



Urbani  
Gloss Painted

Featured colour: Stone taken  
from the Gloss Colour Studio.



Urbani  
Gloss Painted

Featured colour: Alabaster taken  
from the Gloss Colour Studio.

# The Worktop Studio





# A Lifestyle Collection

The 'Worktop Studio' is a collection of timeless and luxurious kitchen work surfaces.

The collection comprises Granite, Quartz, Solid Surface and Timber Worktops to suit all tastes from traditional to contemporary.

The range offers the most popular options for discerning customers.

## Contents

[Granite Colour Palette](#)

[Quartz Colour Palette](#)

[Granite and Quartz  
Edge Profiles](#)

[Imagine with Mistral](#)

[Timber Worktops](#)



# Granite Colour Palette

The Worktop Studio Granite work surfaces showcase a popular spectrum of colours. Granite offers a prestigious look and provides durability for years to come. The applications are endless for granite: create a worktop that is both natural and unique. Granite is a Natural product. Colours and patterns may vary accordingly.

## Granite Group 1



Black Pearl **Group 1**



Eden Grey **Group 1**



Steel Grey **Group 1**



Tan Brown **Group 1**

For technical reasons connected with colour reproduction, colours shown may not be an exact representation of the actual product. Please ask for a sample before ordering.

Please note all images are lifestyle images and do not necessarily represent the product range.

## Granite Group 2 and 3



Impala **Group 2**



Verde Ubatuba **Group 2**



Baltic Brown **Group 3**



Ivory White Fantasy **Group 3**

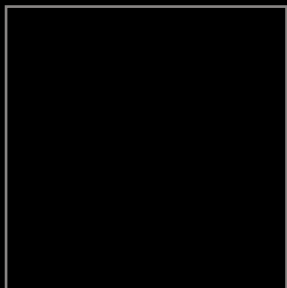

Premium Black **Group 3**





## Granite Group 4 and 5



Blue Pearl **Group 4**



Emerald Pearl **Group 4**



Nero Cosmos **Group 4**



Star Galaxy **Group 4**



Giallo Veneziano **Group 5**

## Quartz Group 4



Bianco Polished **Group 4**



Dark Mist **Group 4**



Light Mist **Group 4**

# Quartz Colour Palette

With a more uniform finish Quartz offers a versatile colour palette offering the freedom for self-expression in design. Star Quartz with the addition of mirror chips, these worktops gives the illusion of light and reflection enhancing any kitchen project.



For technical reasons connected with colour reproduction, colours shown may not be an exact representation of the actual product. Please ask for a sample before ordering.

Please note all images are lifestyle images and do not necessarily represent the product range.



## Quartz Group 4



Sand **Group 4**



Blanco Star **Group 4**

For technical reasons connected with colour reproduction, colours shown may not be an exact representation of the actual product. Please ask for a sample before ordering.

Please note all images are lifestyle images and do not necessarily represent the product range.

## Quartz Group 4



Beige Star Group 4



Nero Star Group 4



Grey Star Group 4





## Granite and Quartz Edge Profiles

The Worktop Studio offers a selection of the most popular edge profiles to choose from.

For a modern subtle profile choose the pencil round edge which will work in almost any kitchen setting. Alternatively choose a more traditional profile such as the Ogee to create a stunning design feature with an elegant classic finish.

The profiles will complete the overall look of the worktop and bring a truly unique style to the finishing.



# Edge Profiles

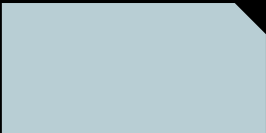

Chamfer

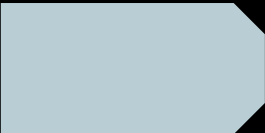

Double Chamfer



Pencil Round



Half Bullnose



Full Bullnose



Dupont



Sharknose



Ogee

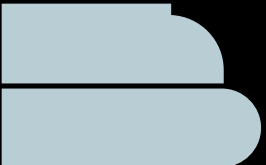

Dupont and Full Bullnose 60mm





## Imagine with Mistral

MISTRAL is a 25mm thick SOLID surface worktop range. There is no chipboard, MDF, or particleboard substrate, just 100% solid surface!

The MISTRAL worktop range combines the breathtaking looks of natural quartz and stone, with the practicality and creative freedom of acrylic based solid surface material to deliver outstanding product value and exceptional aesthetic results.

# MISTRAL



## Durable and Strong!

MISTRAL worktops are entirely non-porous so there are no moisture ingress problems and without a substrate there are no internal joints that may undermine the structural integrity of the worktop.





## 10 Year Manufacturer's Guarantee – Field Tested!

Our 25mm solid surface worktops have been tested in a variety of high impact commercial applications for over 10 years. Be assured, MISTRAL worktops are designed and produced to last!

## Beautifully Seamless Joints!

MISTRAL worktops can be jointed and finished so that the seams are not only smooth but inconspicuous so that your surface flows unbroken as if crafted from a single piece.

## Feature-laden Design Opportunities!

-  MISTRAL's thick surface offers a wealth of possibilities for adding features such as drainer grooves, recessed wet areas around fitted sinks and attractive edge profiles.
-  MISTRAL's pure structure presents the perfect medium for design as it can be shaped to follow your imagination. Free from restriction you can create elegant curves to complement shaped door layouts and tight radii can be used to add detail and character for a truly unique living environment.
-  MISTRAL worktops utilise all the inherent qualities of solid surface technology to provide the ideal surface for your home. It is non-porous so is easy to clean and hygienic as well as being resistant to staining.
-  MISTRAL withstands the general wear and tear of domestic use and has the ability to be replenished so that any marks and scuffs that may appear over time can be abraded away to leave your surfaces looking as though they had just been installed.



# The Colours of MISTRAL

The MISTRAL spectrum provokes an abundance of ideas for colour schemes and combinations as each element of the range contains a fusion of hues and shades. Taking inspiration from some of nature's most beautiful natural stone and quartz we have designed a colour palette to fuel the imagination of architects, designers and homeowners alike.

With our solid surface experience and technologies we have developed these worktop decors with a depth and distinction that will help create the perfect living space.

'Whether your style is elaborate or minimalist, traditional or ultra-modern, your ideal is MISTRAL'

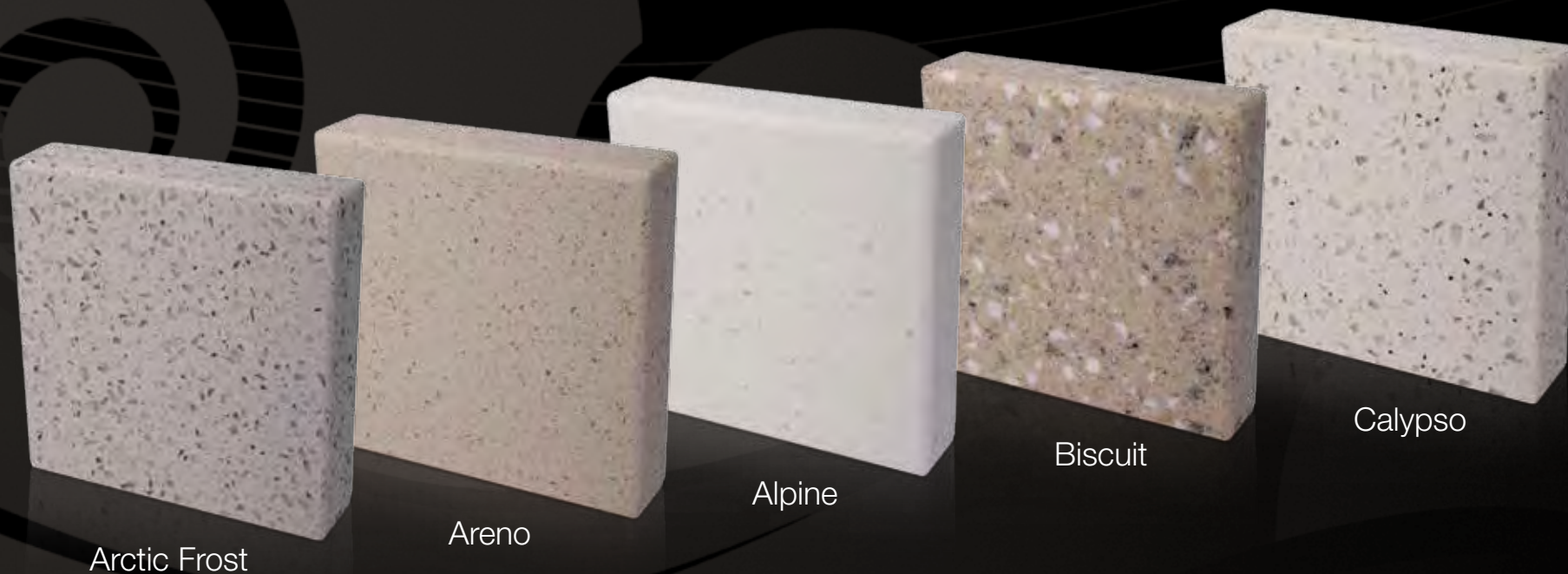

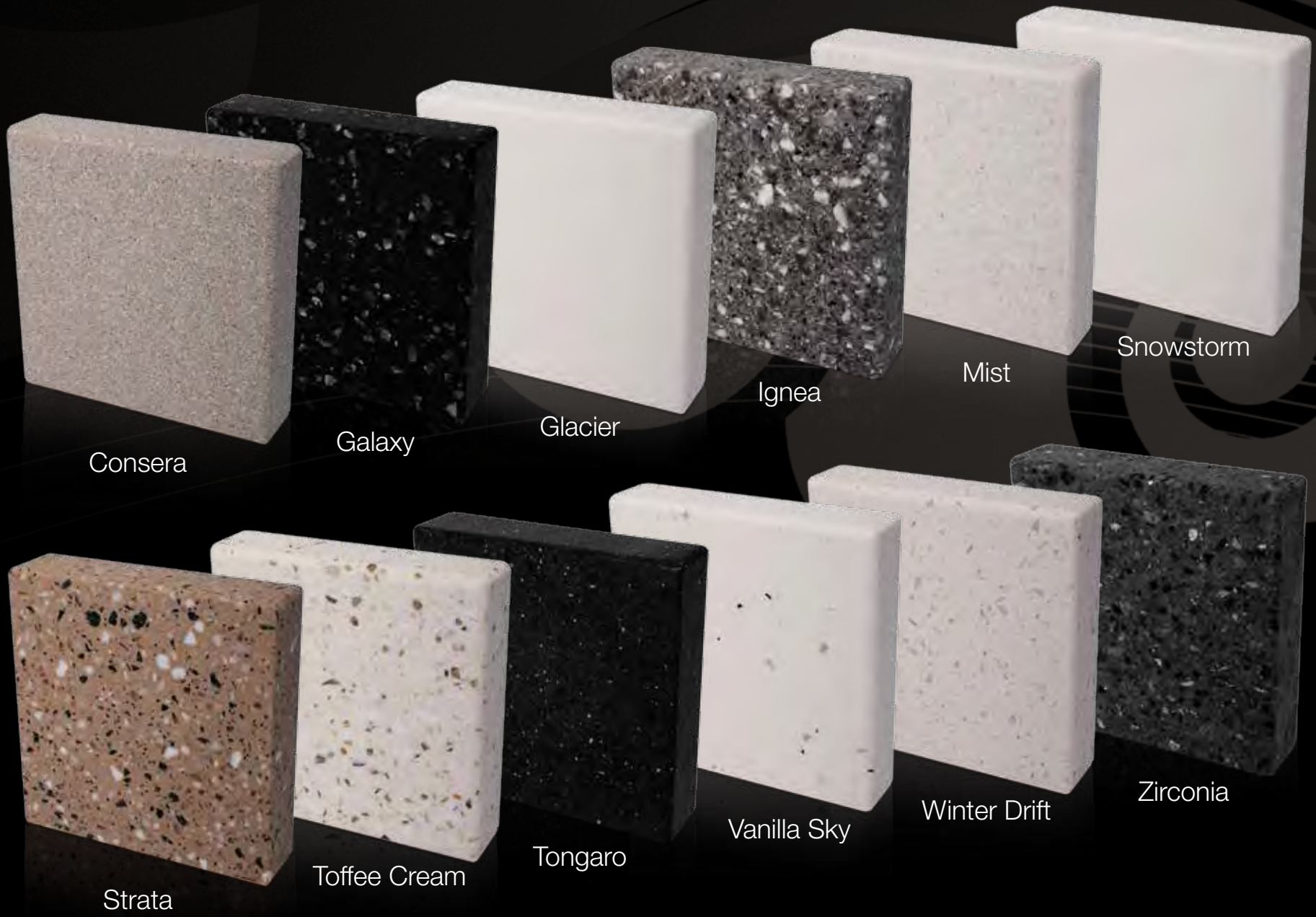

Consera

Galaxy

Glacier

Ignea

Mist

Snowstorm

Strata

Toffee Cream

Tongaro

Vanilla Sky

Winter Drift

Zirconia

# Timber Worktops

Solid timber worktops bring a natural beauty into your kitchen. Timber worktops are both aesthetically pleasing and bring a unique character to your kitchen design. With their timeless look and tactile feel, our wooden worktops create a beautiful individual statement in both traditional and contemporary environments.

We contribute to the World Wildlife Fund and we are committed to conserving the environment. With this philosophy in mind, we have decided against supplying timbers which generate environmental problems with their harvesting and so we do not sell any African timbers. All our wooden worktops are purchased with particular attention to ensuring that the timber is from an environmentally sustainable source.

Wood has a natural defence against bacteria and is considered to be the most hygienic of all kitchen work surfaces.

Our timber worktops are constructed with solid staves and, if correctly installed, will give a lifetime of trouble-free use.

## Full Stave Oak



Full Stave Oak

Natural and quintessentially English. Full Stave Oak has a lot of character. The first choice for those looking for durability, strength and classic traditional elegance.

These worktops offer a stave width between 60mm and 90mm which give the effect of a solid homogenous worktop without the striped appearance.



For technical reasons connected with colour reproduction, colours shown may not be an exact representation of the actual product. Please ask for a sample before ordering.

Please note all images are lifestyle images and do not necessarily represent the product range.



## Finger Jointed Worktops

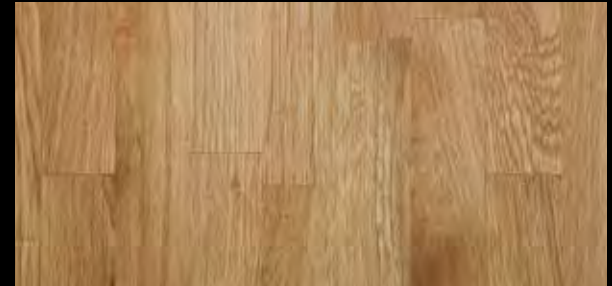

Prime Oak

The first choice for those looking for durability, strength and classic traditional elegance. These worktops have an extremely consistent finish.



Natural Oak

Natural and quintessentially English. Rustic finish with lots of character. Extremely hard wearing and durable with more natural features than Prime Oak.

For technical reasons connected with colour reproduction, colours shown may not be an exact representation of the actual product. Please ask for a sample before ordering.

Please note all images are lifestyle images and do not necessarily represent the product range.



## Finger Jointed Worktops



Natural Steamed Beech

Rustic finish, perfect for that traditional look.



Walnut

A classic hardwood of immense character and warmth. Walnut worktops have fantastic grain patterns and colour variation.



# Sinks and Taps

Astracast is recognised as a market leader in the manufacture of kitchen sinks, taps and accessories, manufacturing for over 29 years across all three sink materials: Stainless Steel, Composite Granite and Ceramic.

Proud to design, develop and manufacture in the UK, creating stunning innovative designs with industry leading quality that will take pride of place in your home for many years to come.

All Astracast products have a comprehensive guarantee which covers the sink against the unlikely event of any material or manufacturing defect. This guarantee is just one part of Astracast's commitment to total quality, assuring you that all products will give you the highest level of performance and lasting good looks for years to come.



ASTRACAST®  
innovation • design • performance

## Parallel Compact

Single Bowl with  
Chrome Monobloc Tap

Product Code: COMPACT/TAP



### Features

- Overall Sink Dimensions: 800 x 500mm  
Bowl depth: 155mm
- Minimum Base Unit: 450mm
- Minimum Tap Pressure: 0.5 Bar
- Includes waste and overflow
- 5 year guarantee\*

\* Excluding tap o-rings and valves which feature a 1 year guarantee

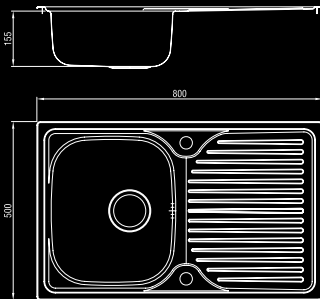

## Parallel

Single Bowl with  
Chrome Monobloc Tap

Product Code: PARALLEL1.0/TAP



### Features

- Overall Sink Dimensions: 965 x 500mm  
Bowl depth: 155mm
- Minimum Base Unit: 500mm
- Minimum Tap Pressure: 0.5 Bar
- Includes waste and overflow
- 5 year guarantee\*

\* Excluding tap o-rings and valves which feature a 1 year guarantee

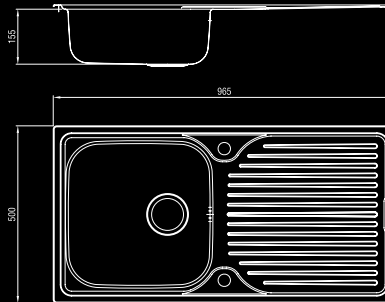

## Parallel

Single Bowl and Half Bowl with  
Chrome Monobloc Tap

Product Code: PARALLEL1.5/TAP



### Features

- Overall Sink Dimensions: 965 x 500mm  
Bowl depth: 155mm, Half bowl: 83mm
- Minimum Base Unit: 500mm
- Minimum Tap Pressure: 0.5 Bar
- Includes waste and overflow in main bowl
- 5 year guarantee\*

\* Excluding tap o-rings and valves which feature a 1 year guarantee

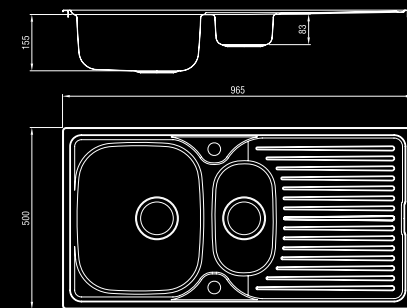

Stainless Steel  
Layon Sinks



ASTRACAST<sup>®</sup>  
innovation • design • performance

## Parallel: Single Bowl

Satin Polish

Product Code: PARALLEL 1.0



### Features

- Overall Dimensions: 965 x 500mm, Bowl Dimensions: 400 x 400 x 155mm
- Minimum Base Unit: 500mm
- Reversible
- Includes: waste and overflow
- 5 year guarantee

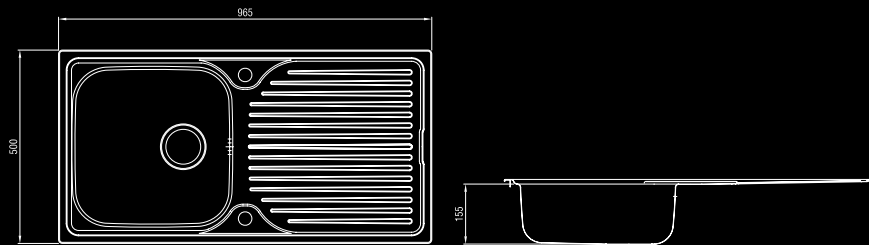

## Parallel: Single & Half Bowl

Satin Polish

Product Code: PARALLEL 1.5



### Features

- Overall Dimensions: 965 x 500mm, Bowl Dimensions: 400 x 340 x 155mm, Half Bowl Dimensions: 300 x 163 x 83mm
- Minimum Base Unit: 500mm
- Reversible
- Includes: waste and overflow in main bowl
- 5 year guarantee

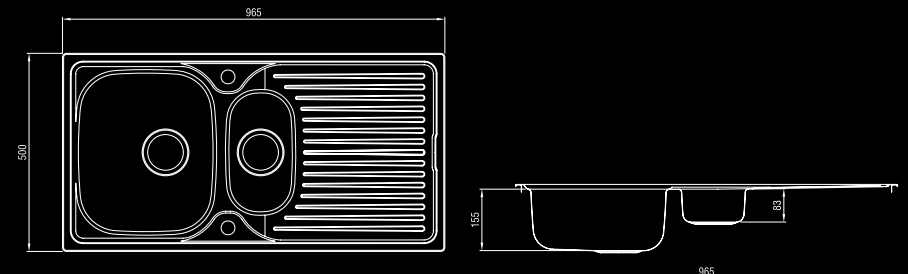

## Luxury Plus: Single Bowl

Satin Polish

Product Code: LUXPLUS1.0



### Features

- Overall Dimensions: 980 x 510mm, Bowl Dimensions: 350 x 410 x 165mm
- Minimum Base Unit: 500mm
- Reversible
- Includes: waste and overflow
- 5 year guarantee

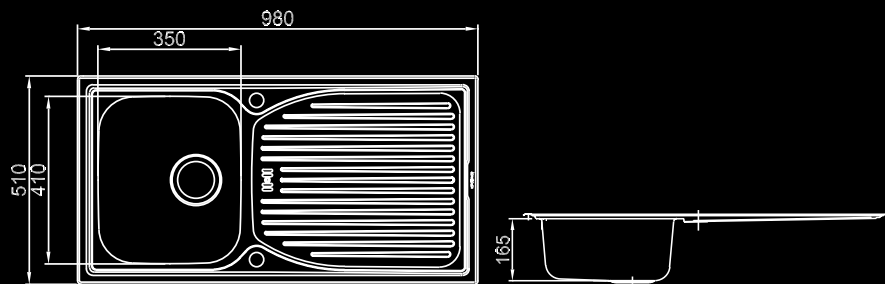

## Luxury Plus: Single & Half Bowl

Satin Polish

Product Code: LUXPLUS1.5



### Features

- Overall Dimensions: 980 x 510mm, Bowl Dimensions: 350 x 410 x 165mm Half Bowl Dimensions: 160 x 305 x 120mm
- Minimum Base Unit: 600mm
- Reversible
- Includes: wastes, pipework and overflow in main bowl
- 5 year guarantee

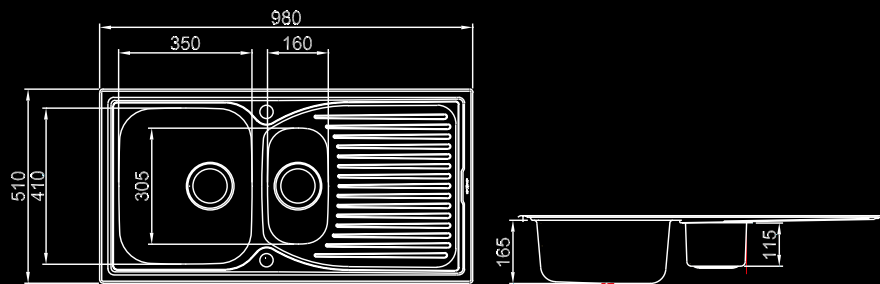

## Pacific: Single Bowl

Satin Polish

Product Code: PACIFIC1.0



### Features

- Overall Dimensions: 1000 x 500mm, Bowl Dimensions: 465 x 415 x 200mm
- Minimum Base Unit: 600mm
- Reversible
- Includes: waste and overflow
- 5 year guarantee

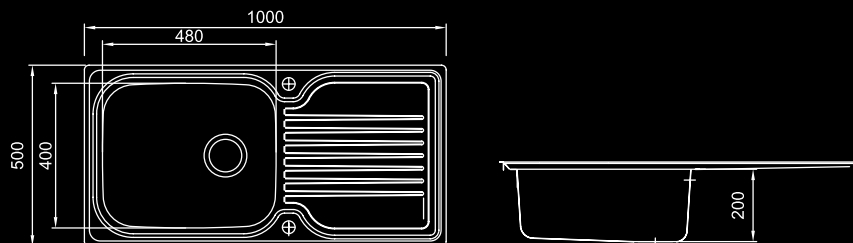

## Pacific: Single & Half Bowl

Satin Polish

Product Code: PACIFIC1.5



### Features

- Overall Dimensions: 1000 x 500mm, Bowl Dimensions: 350 x 415 x 175mm Half Bowl Dimensions: 285 x 160 x 120mm
- Minimum Base Unit: 600mm
- Reversible
- Includes: wastes, pipework and overflow in main bowl
- 5 year guarantee

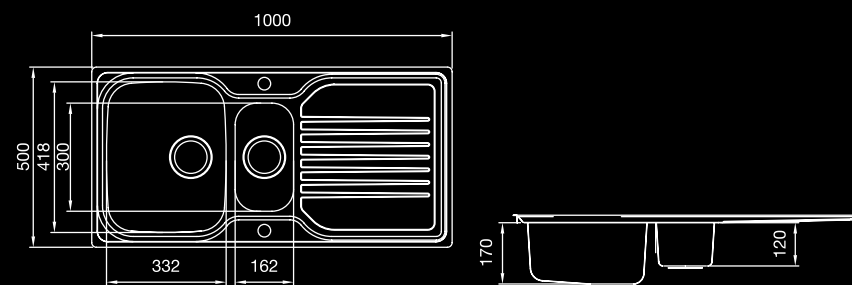



## Composite Sinks

Our ROK® Composite sinks offer the ultimate in performance using real quartz particles to create an extremely resistant finish for even the most hectic of kitchens.

ASTRACAST®  
innovation • design • performance



## Composite: Single Bowl

Volcano Black | Product Code: ROK1.0BL

Opal White | Product Code: ROK1.0WH

Sahara Beige | Product Code: ROK1.0BE



Volcano Black

Sahara Beige

### Features

- Overall Dimensions: 980 x 500mm
- Bowl Depth: 195mm
- Minimum Base Unit: 500mm
- Includes: waste and overflow
- 20 year guarantee

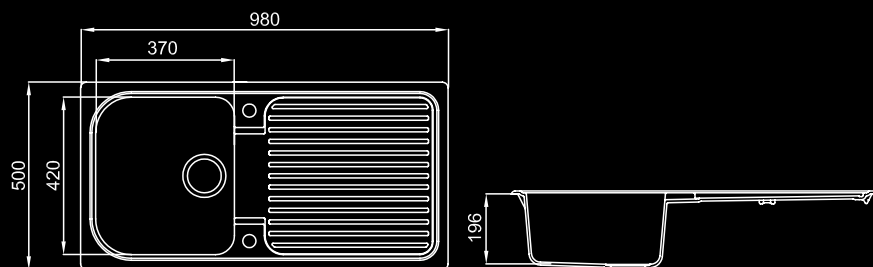

## Composite: Single & Half Bowl

Volcano Black | Product Code: ROK1.5BL

Opal White | Product Code: ROK1.5WH

Sahara Beige | Product Code: ROK1.5BE



Volcano Black

Sahara Beige

### Features

- Overall Dimensions: 980 x 500mm
- Bowl Depth: 195mm Half Bowl Depth: 140mm
- Minimum Base Unit: 600mm
- Includes: wastes, pipework and overflow in main bowl
- 20 year guarantee

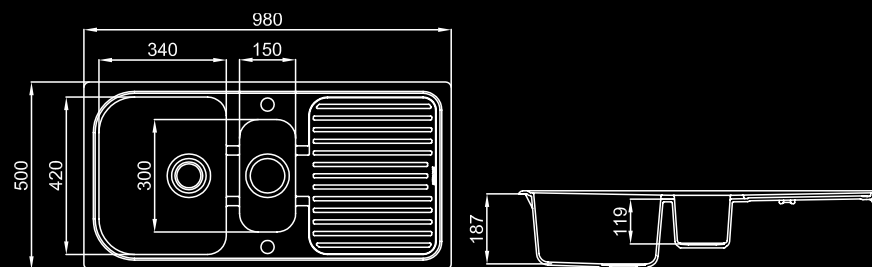



## Ceramic Layon Sinks

Our ceramic sinks are hand crafted from ceramic fireclay with a hardwearing non-porous surface that offers excellent resistance to chemicals, detergents and heat.

**ASTRACAST**<sup>®</sup>  
innovation • design • performance

## Ceramic

Single Bowl

Product Code: CERAMIC1.0



### Features

- Overall Dimensions: 980 x 520mm  
Bowl depth: 190mm
- Minimum Base Unit: 600mm
- Includes waste and overflow
- 5 year guarantee

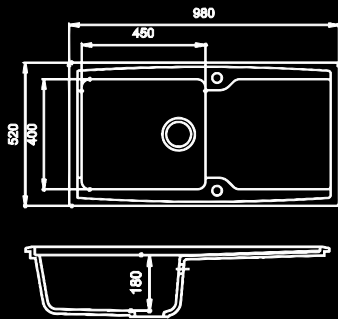

## Ceramic

Single Bowl with Half Bowl

Product Code: CERAMIC1.5



### Features

- Overall Dimensions: 980 x 520mm  
Bowl Depth: 180mm, Half Bowl: 120mm
- Minimum Base Unit: 600mm
- Includes wastes and pipework
- 5 year guarantee

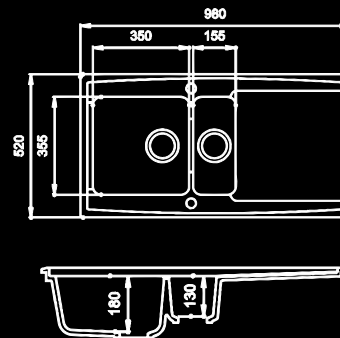

## Ceramic

Belfast

Product Code: BELFAST



### Features

- Overall Dimensions: 595 x 455mm  
Bowl Depth: 225mm
- Minimum Base Unit: Bespoke
- Includes chrome waste and weir overflow
- 5 year guarantee

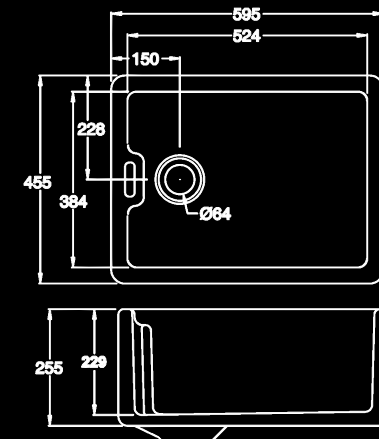



Stainless Steel  
Undermount Sinks

ASTRACAST<sup>®</sup>  
innovation • design • performance

# Topaz

Half Bowl

Product Code: TOPAZ0.5



## Features

- Dimensions: 300 x 162mm
- Bowl Depth: 120mm
- Min Base Unit: 400mm
- Includes waste
- 5 year guarantee

Please note the sink dimensions are OVERALL DIMENSIONS

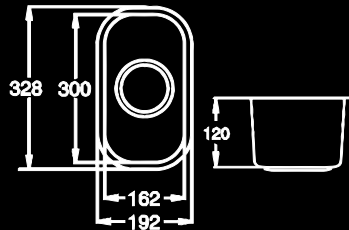

# Topaz

Medium Bowl

Product Code: TOPAZMED



## Features

- Dimensions: 332 x 418mm
- Bowl Depth: 170mm
- Min Base Unit: 500mm
- Includes waste & overflow
- 5 year guarantee

Please note the sink dimensions are OVERALL DIMENSIONS

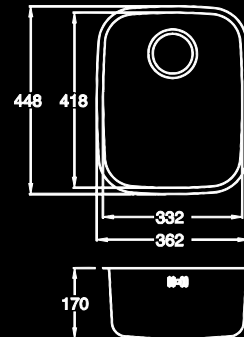

# Topaz

Large Bowl

Product Code: TOPAZLAR



## Features

- Dimensions: 478 x 330mm
- Bowl Depth: 187mm
- Min Base Unit: 600mm
- Includes waste & overflow
- 5 year guarantee

Please note the sink dimensions are OVERALL DIMENSIONS

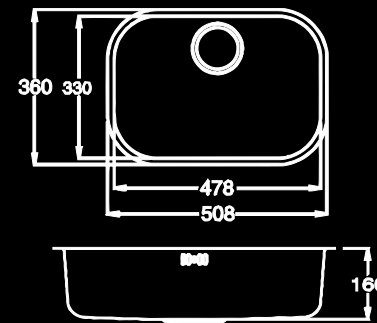

# Topaz

Single & Half Bowl

L/Hand Code: TOPAZ1.5L

R/Hand Code: TOPAZ1.5R



Righthand version

## Features

- Dimensions: 580 x 450mm
- Bowl Depth: 180mm
- Half Bowl Depth: 120mm
- Min Base Unit: 600mm
- Includes waste & overflow
- 5 year guarantee

Please note the sink dimensions are OVERALL DIMENSIONS

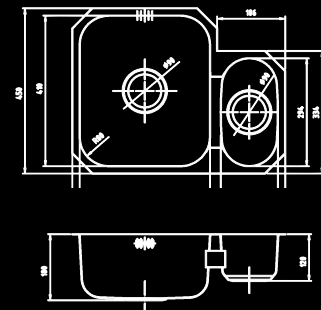



Stainless Steel  
Undermount Sinks

ASTRACAST®  
innovation • design • performance

## Onyx

Polished Round Bowl

Product Code: ONYXRB



### Features

- Bowl Diameter: 430mm
- Bowl depth: 150mm
- Minimum Base Unit: 500mm
- Includes waste and overflow
- Lifetime guarantee

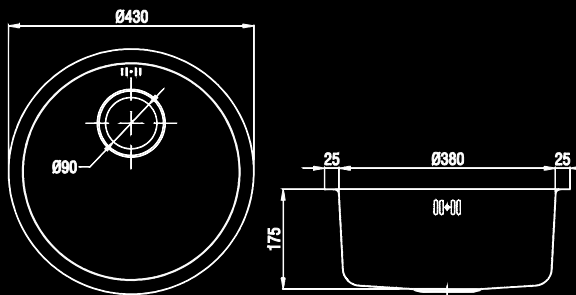

## Onyx

Polished Round Drainer

Product Code: ONYXRB



### Features

- Drainer Diameter: 430mm
- Drainer depth: 34mm
- Minimum Base Unit: 500mm
- Includes waste
- Lifetime guarantee

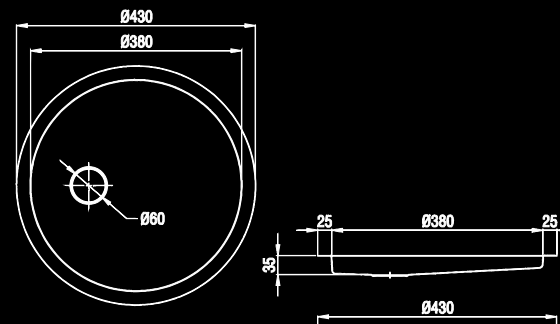

## Onyx

Brushed 4016 Bowl

Product Code: ONYX4016



### Features

- Overall Dimensions: 192 x 430mm
- Bowl depth: 110mm
- Minimum Base Unit: 400mm
- Includes waste
- Lifetime guarantee

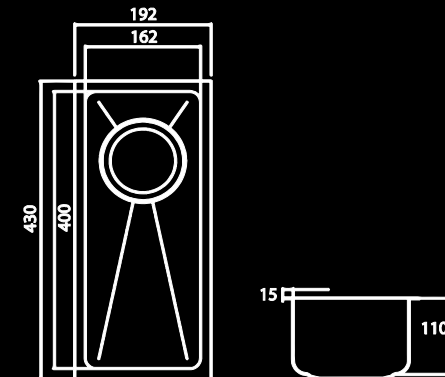

## Onyx

Brushed 4034 Bowl

Product Code: ONYX4034



### Features

- Overall Dimensions: 370 x 430mm
- Bowl depth: 225mm
- Minimum Base Unit: 450mm
- Includes waste and overflow
- Lifetime guarantee

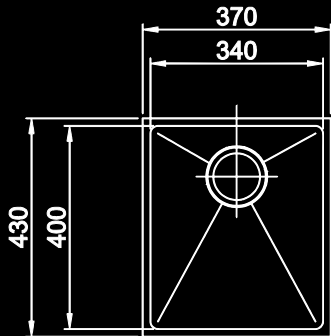

## Onyx

Brushed 4034 Drainer

Product Code: ONYX4034D



### Features

- Overall Dimensions: 370 x 430mm
- Bowl depth: 25mm
- Minimum Base Unit: 450mm
- Includes waste and overflow
- Lifetime guarantee

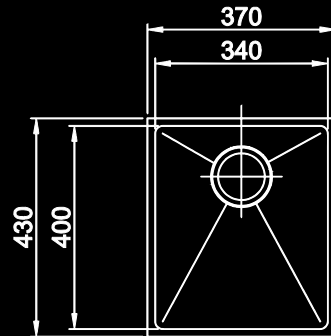

## Onyx

Brushed 4054 Bowl

Product Code: ONYX4054



### Features

- Overall Dimensions: 570 x 430mm
- Bowl depth: 225mm
- Minimum Base Unit: 800mm
- Includes waste and overflow
- Lifetime guarantee

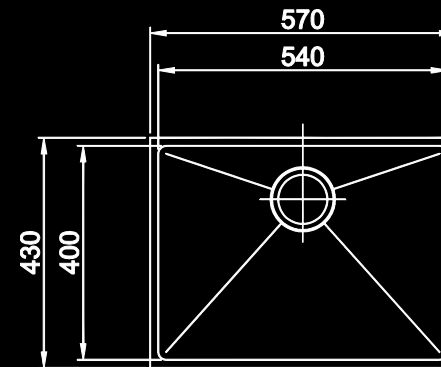



## Onyx

Brushed 4070XL Bowl

Product Code: ONYX4070



### Features

- Overall Dimensions: 730 x 430mm
- Bowl depth: 190mm
- Minimum Base Unit: 800mm
- Includes waste and overflow
- Lifetime guarantee

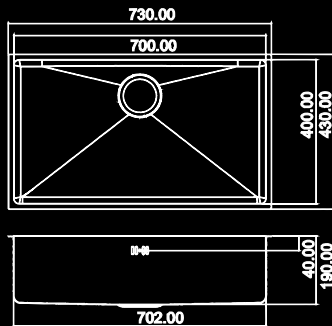

## Onyx

Brushed 4034 1.5 Bowl

Product Code: ONYX4053



### Features

- Overall Dimensions: 558 x 430mm
- Main bowl depth: 225mm, Half Bowl: 110mm
- Minimum Base Unit: 600mm
- Includes wastes and overflow
- Lifetime guarantee

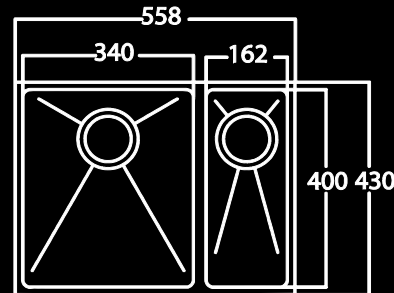

## Onyx

Brushed 407 2.0 Bowl

Product Code: ONYX40702B



### Features

- Overall Dimensions: 735 x 430mm
- Bowl depth: 225mm
- Minimum Base Unit: 800mm
- Includes wastes and overflow
- Lifetime guarantee

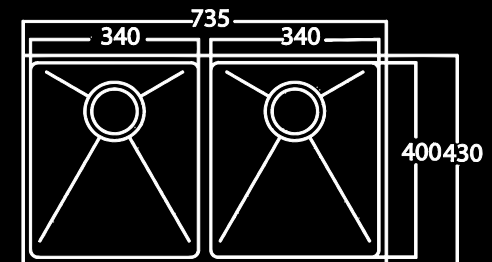



Ceramic Undermount Sinks

ASTRACAST<sup>®</sup>  
innovation · design · performance

## Lincoln

Half Bowl

Prod Code: LINCOLN2540



### Features

- Dimensions: 310 x 460mm
- Bowl Depth: 160mm
- Min Base Unit: 400mm
- Includes waste & overflow
- Lifetime guarantee

Please note the sink dimensions are OVERALL DIMENSIONS

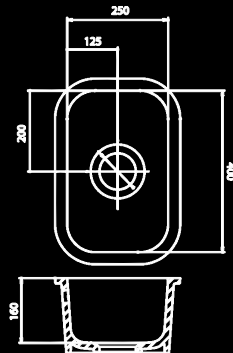

## Lincoln

Medium Bowl

Prod Code: LINCOLN4040



### Features

- Dimensions: 460 x 460mm
- Bowl Depth: 180mm
- Min Base Unit: 500mm
- Includes waste & overflow
- Lifetime guarantee

Please note the sink dimensions are OVERALL DIMENSIONS

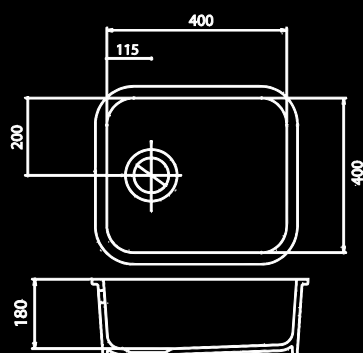

## Lincoln

Large Bowl

Prod Code: LINCOLN5040



### Features

- Dimensions: 560 x 460mm
- Bowl Depth: 180mm
- Min Base Unit: 600mm
- Includes waste & overflow
- Lifetime guarantee

Please note the sink dimensions are OVERALL DIMENSIONS

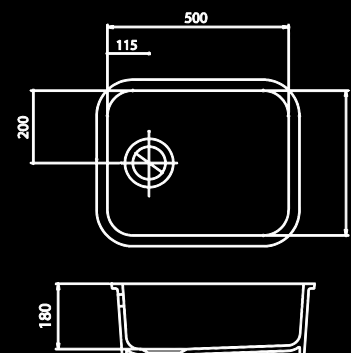

## Lincoln

1.5 Bowl RHD

Prod Code: LINCOLN1.5R



### Features

- Dimensions: 544 x 440mm
- Bowl Depth: 180mm
- Half Bowl Depth: 116mm
- Min Base Unit: 600mm
- Includes wastes
- Lifetime guarantee

Please note the sink dimensions are OVERALL DIMENSIONS

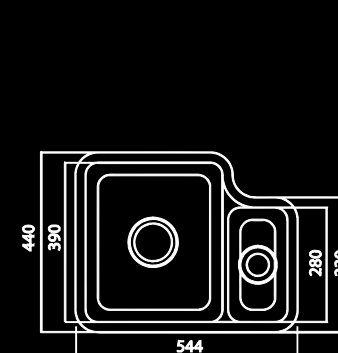

## Lincoln

1.5 Bowl LHD

Prod Code: LINCOLN1.5L



### Features

- Dimensions: 544 x 440mm
- Bowl Depth: 180mm
- Half Bowl Depth: 116mm
- Min Base Unit: 600mm
- Includes wastes
- Lifetime guarantee

Please note the sink dimensions are OVERALL DIMENSIONS

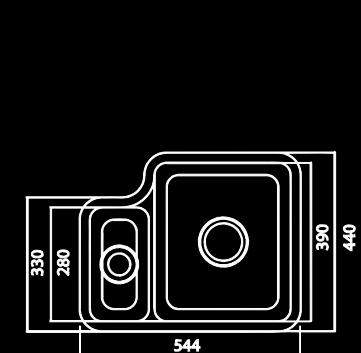

ASTRACAST<sup>®</sup>  
innovation • design • performance

Taps



ASTRACAST<sup>®</sup>  
innovation · design · performance

## Ariel

Single Lever Chrome Tap

Product Code: TAPARIEL



### Features

- Dimensions: 192 x 213 x 139mm
- Min Pressure: 1.0 bar
- Tap hole diameter: 35mm
- 5 year guarantee\*

\* Excluding tap o-rings and valves which feature a 1 year guarantee

## Orinoco

Single Lever Chrome Tap

Product Code: TAPORINOCO



### Features

- Dimensions: 320 x 200 x 245mm
- Min Pressure: 0.5 bar
- Tap hole diameter: 35mm
- 5 year guarantee\*

\* Excluding tap o-rings and valves which feature a 1 year guarantee

## Targa

Quarter Turn Chrome Tap

Product Code: TAPTARGA



### Features

- Dimensions: 238 x 225 x 205mm
- Min Pressure: 0.1 bar
- Tap hole diameter: 35mm
- 5 year guarantee\*

\* Excluding tap o-rings and valves which feature a 1 year guarantee

## Professional

Single Lever Chrome Tap

Product Code: TAPPRO

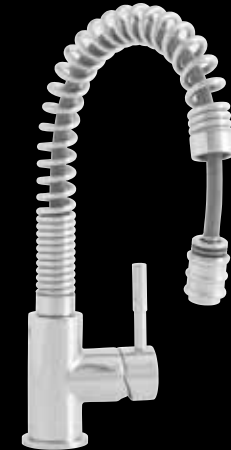

### Features

- Dimensions: 355 x 231 x 225mm
- Min Pressure: 1.0 bar
- Tap hole diameter: 35mm
- 5 year guarantee\*

\* Excluding tap o-rings and valves which feature a 1 year guarantee

## Shannon

Quarter Turn Chrome Tap

Product Code: TAPSHAN



### Features

- Dimensions: 357 x 169 x 249mm
- Min Pressure: 0.1 bar
- Tap hole diameter: 35mm
- 5 year guarantee\*

\* Excluding tap o-rings and valves which feature a 1 year guarantee

## Shannon (Pullout)

Quarter Turn Chrome Tap

Product Code: TAPSHANP



### Features

- Dimensions: 357 x 173 x 231mm
- Min Pressure: 0.5 bar
- Tap hole diameter: 35mm
- 5 year guarantee\*

\* Excluding tap o-rings and valves which feature a 1 year guarantee

## Kuban

Single Lever Chrome Tap

Product Code: TAPKUBAN



### Features

- Dimensions: 205 x 156 x 156mm
- Min Pressure: 0.5 bar
- Tap hole diameter: 35mm
- 5 year guarantee\*

\* Excluding tap o-rings and valves which feature a 1 year guarantee

## Colonial

Quarter Turn Chrome Tap

Product Code: TAPCOLON

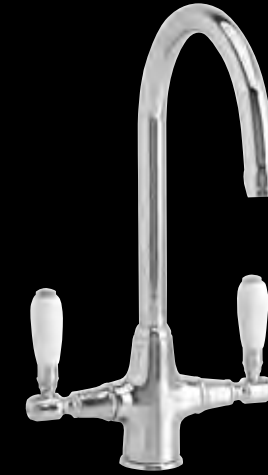

### Features

- Dimensions: 382 x 193 x 252mm
- Min Pressure: 0.1 bar
- Tap hole diameter: 35mm
- 5 year guarantee\*

\* Excluding tap o-rings and valves which feature a 1 year guarantee

## Leda

Single Lever Chrome Tap

Product Code: TAPLEDA

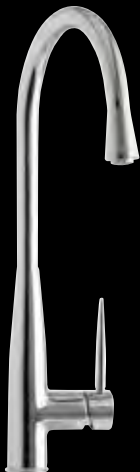

### Features

- Dimensions: 492 x 213 x 320mm
- Min Pressure: 0.5 bar
- Tap hole diameter: 35mm
- 5 year guarantee\*

\* Excluding tap o-rings and valves which feature a 1 year guarantee

## V Form

Lever Turn Chrome Tap

Product Code: TAPVFORM



### Features

- Dimensions: 377 x 210 x 279mm
- Min Pressure: 0.1 bar
- Tap hole diameter: 35mm
- 5 year guarantee\*

\* Excluding tap o-rings and valves which feature a 1 year guarantee



# Door handles

A complete range of handles in a variety of designs to complement both contemporary and classical kitchens. Choose from a selection of finishes including: Nickel Plated, Chrome, Stainless Steel, Antique, Pewter and Decorative.

Various handles available in different sizes.



Nickel Plated





20081/64CR



10265/160CR



10297/32CR



10343/160CR



10345/160CR



10374/160CR



10376/160CR

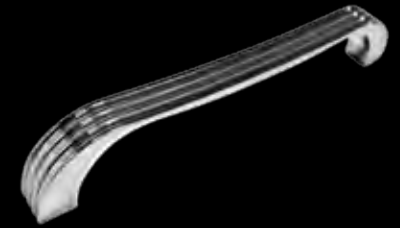

10413/160CR

Chrome



10414/160CR



10105/160CR



20057/160CR

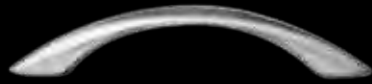

10150/96SS



10015/96SS



10311/128SS



10040/128SS



10082/160SS



10082/192SS



10083/128SS



10152/128SS



TH168 - 645SS



10156/160SS



10175/128SS



MS178 - MS338SS



60089/SS



SNK33SS



BR143/SS



BW156 - BW364/SS



BL173 - BL1125/SS

Antique Pewter



DN174IR



IH156IR



DN35IR



IK38IR



PTD188P

Silver



10180



10181/96

Decorative



CRYST40D



CRYST29D



GLITTD128S



GLITTD128B



## Wicker Baskets

These kitchen wicker baskets offer a practical and attractive storage solution for fruit and vegetables.

The natural materials and simple design will complement any kitchen, whilst the wicker allows air to circulate around the fruit and vegetables, keeping them fresher for longer. The baskets are fully removable making them simple to clean and fill, and can be installed behind a normal sized door.

Each wicker basket is supplied complete with a wooden frame and runners. The frame gives added strength to the wickerwork and the runners allow the basket to slide out from the unit for easy access.

Fitting of the unit is very simple, with pre-drilled holes in the runners to fix to the cabinet sides making this range ideal to retro-fit into an existing kitchen.

### Sizes Available

- 500mm
- 600mm

## Stainless Steel Plinths

Stainless steel plinths are finished in a contemporary brushed steel effect with a clear plastic edge strip to give a neat finish. Use with gloss doors for the ultimate modern contrast.



Left hand plinth



Right hand plinth





## Kitchen Extractors



### EX600C

- 600mm Curved glass chimney
- Stainless steel and glass
- Electronic push controls complete with halogen bulbs and aluminium filters
- 3 Speed extraction to max 600 cubic metres per hour

A range of cooker hoods which vary in terms of aesthetics, extraction and style. Available in both stainless steel or glass finishes. A range of ducting and vents are available - please see our price list for details.



### EX900C

- 900mm Curved glass chimney
- Stainless steel and glass
- Electronic push controls complete with halogen bulbs and aluminium filters
- 3 Speed extraction to max 600 cubic metres per hour



### EX600

- 600mm Stainless steel chimney
- Stainless steel
- Electronic push controls complete with halogen bulbs and aluminium filters
- 3 Speed extraction to max 600 cubic metres per hour



### EX900

- 900mm Stainless steel chimney
- Stainless steel
- Electronic push controls complete with halogen bulbs and aluminium filters
- 3 Speed extraction to max 600 cubic metres per hour



## Breakfast Bar Support Leg

Breakfast bar legs give great support in a kitchen environment. For supporting worktops as an alternative to a table. Add a modern look to your home.

### Features

- Chrome finish
- Available in sizes 710mm and 870mm
- 60mm diameter



## Aluminium Plinth Vents

Used to vent excess heat through your plinth.



Image for illustrative purposes only



## Pop Up Sockets



Code: EPSI

- EVOline® port with silver lacquered plastic cover
- Silver anodised aluminium profile
- 3 x UK sockets
- Installed in a 102mm dia hole



Code: MAKPORT

- 3 UK sockets
- Silver cover & collar
- On and off switch
- Power supply cable
- 13A, 240V
- Installed in a 100mm dia hole
- Best value option





Sige Storage Solutions

The Sige product range has gained an enviable reputation across the world for top quality performance and reliability. If you want quality wirework that is problem-free long after installation then Sige should be your automatic product choice. Sige offer exceptional quality and excellent value for money. The Sige range is continually being improved and is now seen as one of the top quality wirework brands in the world.

The Sige products are tested to the exacting 'CATAS' standards with particular focus on technical, food-safe and environmental aspects. Rest assured that production of the Sige product has a minimal effect on the environment.

Each product is subjected to an extreme test of 80,000 or 100,000 cycles. To put this into perspective, 100,000 cycles is equivalent to at least 15-20 years normal use in an average kitchen.

The following products are selected from a huge range as being the best sellers in the Sige range but many more products can be available on request on realistic lead times. Choose from our fantastic two stylish kitchen storage designs: Classic or Plus.



Classic  
(Round Bar) Style



Plus  
(Flat Bar) Style

# Magic Corner

## Magic Corner Unit.

**Features:** Self-opening and soft-closing.

**Options:** MFC baskets, chrome baskets.

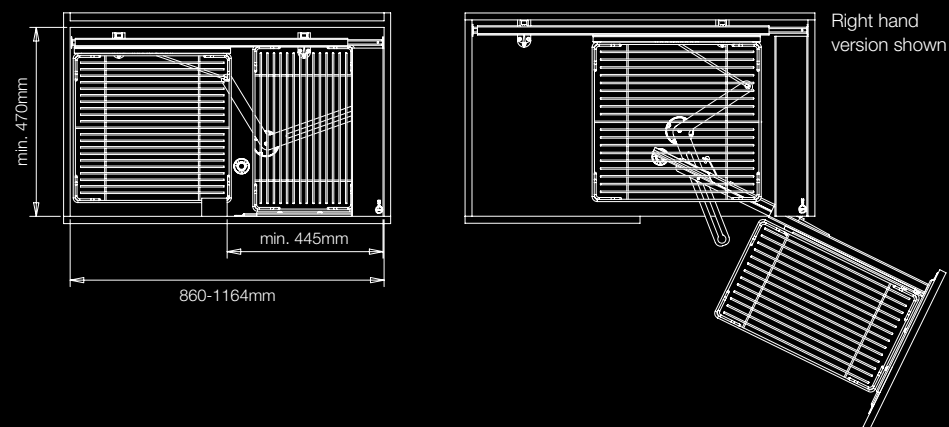

Code	Description	Min Carcase size	Loading
MCUSCL	Magic corner, 860x450mm, silver/chrome baskets, left hand	860x470x580mm	15kg for front, 20kg for corner pullout
MCUSCR	Magic corner, 860x450mm, silver/chrome baskets, right hand	860x470x580mm	15kg for front, 20kg for corner pullout
MCUSML	Magic corner, 860x450mm, silver/MFC bottom baskets, left hand	860x470x580mm	15kg for front, 20kg for corner pullout
MCUSMR	Magic corner, 860x450mm, silver/MFC bottom baskets, right hand	860x470x580mm	15kg for front, 20kg for corner pullout

Note: Carcase sizes given are internal dimensions in width x depth x height



# Magic Corner Plus



## Infinity Plus Magic Corner Unit.

**Features:** Pull-out mechanism for corner cabinet, with soft opening-closing and 4 solid base baskets. Left or right hand. Melamine base with flat bar design.

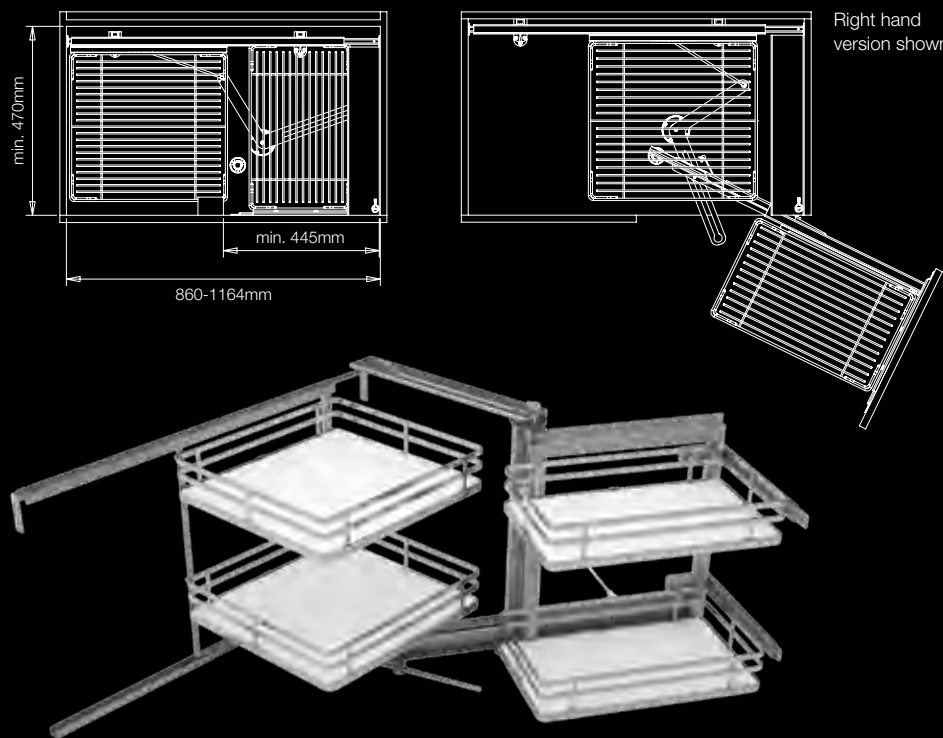

Code	Description	Min Carcase size	Loading
MCUSCLPL	Magic corner, 860x450mm, silver/MFC bottom baskets, left hand	860x470x580mm	15kg for front, 20kg for corner pullout
MCUSCRPL	Magic corner, 860x450mm, silver/MFC bottom baskets, right hand	860x470x580mm	15kg for front, 20kg for corner pullout

Note: Carcase sizes given are internal dimensions in width x depth x height



# Nuvola Pullout

## Nuvola Pullout.

**Features:** Soft-closing option available as extra.

**Options:** MFC baskets. 450mm, 500mm & 600mm versions available.

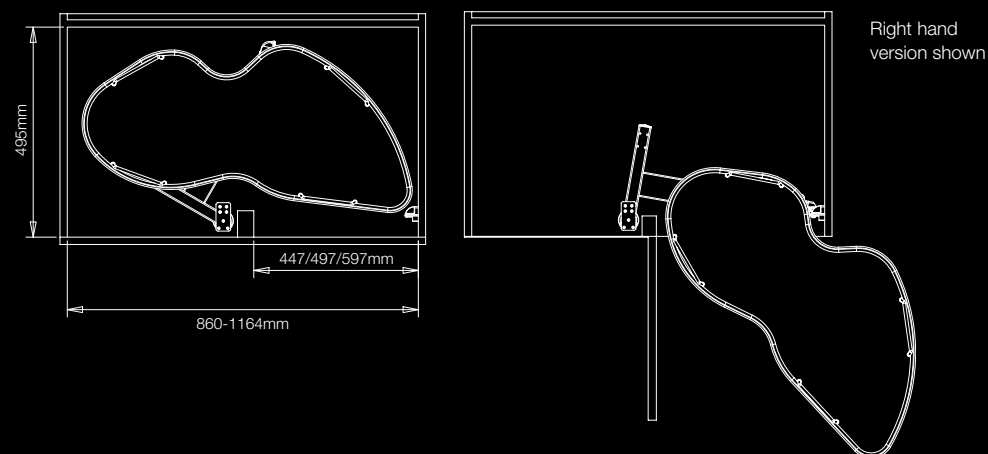

Code	Description	Min Carcase size	Loading
NUV450L	Nuvola, 450mm door, left hand	864x495x600mm	20kg per shelf, 40kg per unit
NUV450R	Nuvola, 450mm door, right hand	864x495x600mm	20kg per shelf, 40kg per unit
NUV500L	Nuvola, 500mm door, left hand	964x495x600mm	20kg per shelf, 40kg per unit
NUV500R	Nuvola, 500mm door, right hand	964x495x600mm	20kg per shelf, 40kg per unit
NUV600L	Nuvola, 600mm door, left hand	964x495x600mm	20kg per shelf, 40kg per unit
NUV600R	Nuvola, 600mm door, right hand	964x495x600mm	20kg per shelf, 40kg per unit
NUVSOFT	Soft close for Nuvola		

Note: Carcase sizes given are internal dimensions in width x depth x height



# Nuvola Pullout Plus



## Infinity Plus Nuvola Pullout.

**Features:** Pull-out shelves for corner cabinet, two melamine bottom shelves with chromed wire rail. Right and left version.  
Not soft closing.  
Please note requires shelves to fix to.

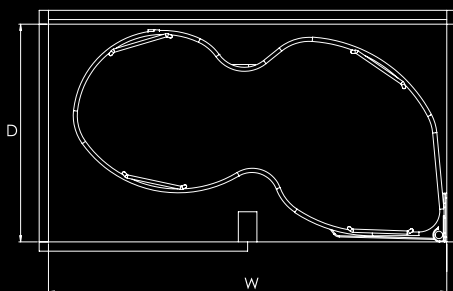

Right hand version shown



Code	Description	Min Carcase size	Loading
NUV450LPL	Nuvola, 450mm door, left hand	864x495x600mm	20kg per shelf, 40kg per unit
NUV450RPL	Nuvola, 450mm door, right hand	864x495x600mm	20kg per shelf, 40kg per unit
NUV500LPL	Nuvola, 500mm door, left hand	964x495x600mm	20kg per shelf, 40kg per unit
NUV500RPL	Nuvola, 500mm door, right hand	964x495x600mm	20kg per shelf, 40kg per unit
NUV600LPL	Nuvola, 600mm door, left hand	964x495x600mm	20kg per shelf, 40kg per unit
NUV600RPL	Nuvola, 600mm door, right hand	964x495x600mm	20kg per shelf, 40kg per unit

Note: Carcase sizes given are internal dimensions in width x depth x height



# Larder Pullout

## Larder Pullout.

**Features:** Self-opening and soft-closing. Full extension.  
Height adjustable: between 1880mm and 2175mm.  
5 baskets (additional baskets available).

**Options:** Chrome baskets, MFC baskets.



Code	Description	Min Carcase size	Loading
LF300SC	Larder pullout, 300mm, silver / 5 chrome baskets	250x455x1880-2175mm	90kg
LF400SC	Larder pullout, 400mm, silver / 5 chrome baskets	350x455x1880-2175mm	90kg
LF450SC	Larder pullout, 450mm, silver / 5 chrome baskets	400x455x1880-2175mm	90kg
LF500SC	Larder pullout, 500mm, silver / 5 chrome baskets	450x455x1880-2175mm	90kg
LF600SC	Larder pullout, 600mm, silver / 5 chrome baskets	550x455x1880-2175mm	90kg
LF300/500SM	Larder Pullout, 300mm silver / 5 MFC bottom baskets	250x500x1880-2175mm	120kg
LF400/500SM	Larder Pullout, 400mm silver / 5 MFC bottom baskets	350x500x1880-2175mm	120kg
LF450/500SM	Larder Pullout, 450mm silver / 5 MFC bottom baskets	400x500x1880-2175mm	120kg
LF500/500SM	Larder Pullout, 500mm silver / 5 MFC bottom baskets	450x500x1880-2175mm	120kg
LF600/500SM	Larder Pullout, 600mm silver / 5 MFC bottom baskets	550x500x1880-2175mm	120kg

Note: Carcase sizes given are internal dimensions in width x depth x height





# Larder Pullout Plus



## Infinity Plus Larder Pullout.

**Features:** Soft-closing. Full extension.  
Height adjustable: between 1880mm and 2175mm.  
5 baskets (additional baskets available).

**Options:** MFC baskets.



Code	Description	Min Carcase size	Loading
LF300SMPL	Larder pullout, 300mm, silver / 5 MFC bottom baskets	300x455x1880-2175mm	120kg
LF400SMPL	Larder pullout, 400mm, silver / 5 MFC bottom baskets	350x455x1880-2175mm	120kg
LF450SMPL	Larder pullout, 450mm, silver / 5 MFC bottom baskets	400x455x1880-2175mm	120kg
LF500SMPL	Larder pullout, 500mm, silver / 5 MFC bottom baskets	450x455x1880-2175mm	120kg
LF600SMPL	Larder pullout, 600mm, silver / 5 MFC bottom baskets	550x455x1880-2175mm	120kg

Note: Carcase sizes given are internal dimensions in width x depth x height



# Duetto Pullout

## Duetto Pullout.

**Features:** Self opening and soft-closing. 6 baskets.  
Reversible and can be doubled up to make a 'Chef's Pantry'.  
Universal – can be used right or left handed.

**Options:** Chrome baskets.

**Loading Capacity:** 20kg front baskets, 50kg rear baskets.

Code	Description	Min Carcase size	Loading
DP450C	Duetto pullout, 450mm, chrome baskets	410x470x1800mm	20kg for small shelves, 50kg for large shelves
DP500C	Duetto pullout, 500mm, chrome baskets	460x470x1800mm	20kg for small shelves, 50kg for large shelves
DP600C	Duetto pullout, 600mm, chrome baskets	560x470x1800mm	20kg for small shelves, 50kg for large shelves



# Duetto Pullout Plus



**Features:** Pull-out tandem dispenser, short (universal), with soft opening-closing and solid base baskets.

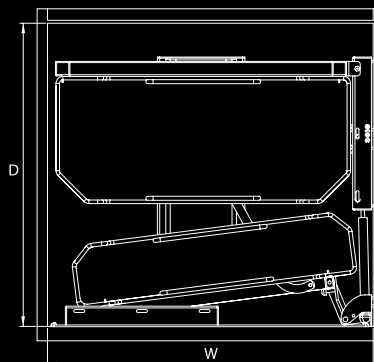

Code	Description	Min Carcase size	Loading
DP450PL/1215	Duetto pullout, 450mm silver/MFC bottom baskets	410x470x1215mm	20kg for small shelves, 50kg for large shelves
DP500PL/1215	Duetto pullout, 500mm silver/MFC bottom baskets	460x470x1215mm	20kg for small shelves, 50kg for large shelves
DP600PL/1215	Duetto pullout, 600mm silver/MFC bottom baskets	560x470x1215mm	20kg for small shelves, 50kg for large shelves

Note: Carcase sizes given are internal dimensions in width x depth x height



# Duetto Pullout Plus



**Features:** Pull-out tandem dispenser, tall (universal), with soft opening-closing and 12 solid base baskets.

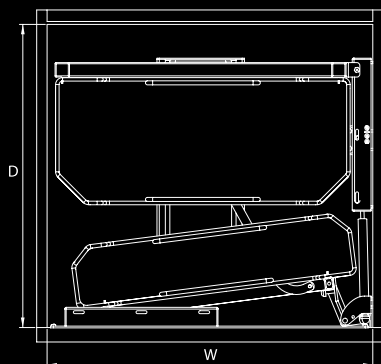

Code	Description	Min Carcase size	Loading
DP450G PL	Duetto pullout, 450mm silver/ MFC bottom baskets	410x470x1800mm	20kg for small shelves, 50kg for large shelves
DP500G PL	Duetto pullout, 500mm silver/ MFC bottom baskets	460x470x1800mm	20kg for small shelves, 50kg for large shelves
DP600G PL	Duetto pullout, 600mm silver/ MFC bottom baskets	560x470x1800mm	20kg for small shelves, 50kg for large shelves

Note: Carcase sizes given are internal dimensions in width x depth x height



# Curvato Pullout

## Curvato Curved Pullout.

**Features:** A unique storage system for curved units.  
Soft-closing. Full extension.

**Options:** Chrome baskets.



Right hand version shown



Right hand version shown



Right hand version shown.  
For illustrative purposes only.

Code	Description	Min Carcase size	Loading
CURVL	Curvato door pullout, silver/ chrome baskets, left hand	272x510x520mm	30kg
CURVR	Curvato door pullout, silver/ chrome baskets, right hand	272x510x520mm	30kg



Note: Carcase sizes given are internal dimensions in width x depth x height

# Base Pullout

## Base Unit Pullout.

**Features:** Soft closing. Full extension.

Code	Description	Min Carcase size	Loading
JB300	Base pullout, 300mm, Jolly basket	264x455x520mm	30kg
JB400	Base pullout, 400mm, Jolly basket	364x455x520mm	30kg



# Base Unit Plus



## Infinity Plus Base Pullout Unit

**Features:** Solid base pull-out basket with full extension slides and soft closing.

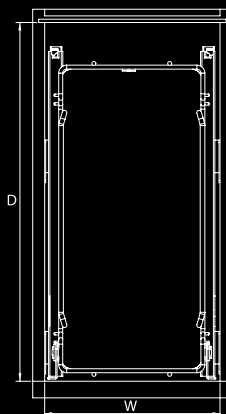

Code	Description	Min Carcase size	Loading
BP300PL	Base pullout, 300mm base pullout, silver/MFC bottom baskets	264x455x520mm	30kg
BP400PL	Base pullout, 400mm base pullout, silver/MFC bottom baskets	364x455x520mm	30kg
BP450PL	Base pullout, 450mm base pullout, silver/MFC bottom baskets	414x455x520mm	30kg
BP500PL	Base pullout, 500mm base pullout, silver/MFC bottom baskets	464x455x520mm	30kg
BP600PL	Base pullout, 600mm base pullout, silver/MFC bottom baskets	564x455x520mm	30kg

Note: Carcase sizes given are internal dimensions in width x depth x height

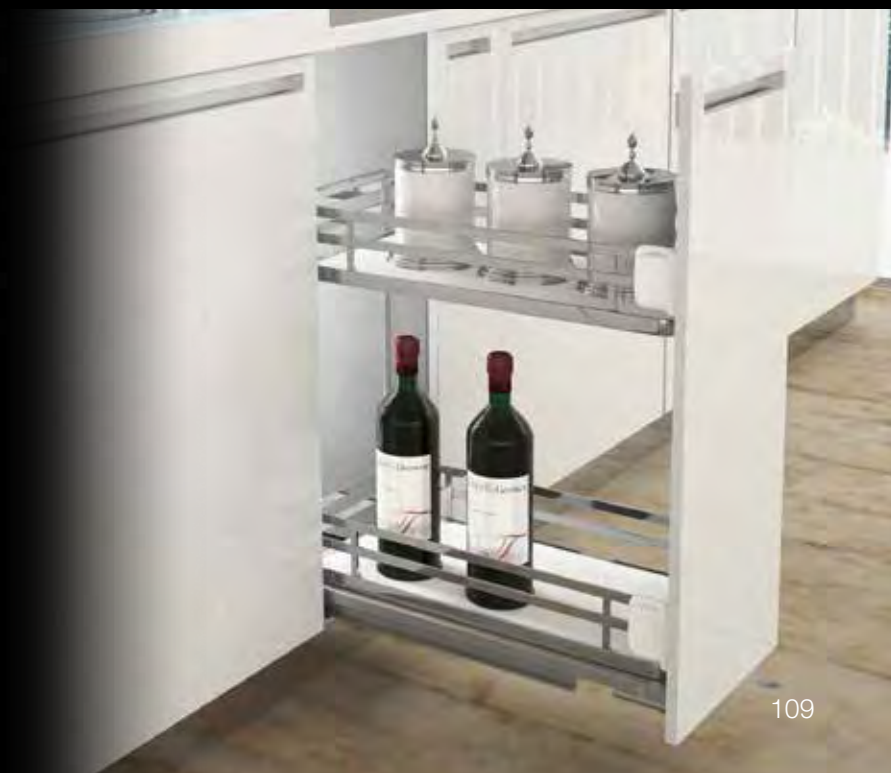

# Angolo Pullout

## Angolo 45° Angled Pullout.

**Features:** Self-opening and soft-closing.  
Full extension.

**Options:** Chrome baskets.



Code	Description	Min Carcase size	Loading
AP300L	Angolo pullout, 45, 300mm, chrome baskets, Left hand	210x520x655mm	40kg
AP300R	Angolo pullout, 45, 300mm, chrome baskets, right hand	210x520x655mm	40kg

Left hand version shown



# Wire Carousel

## Wire Carousel.

**Features:** Closes to reset position.



Code	Description	Min Carcase size	Loading
WC180	1/2 Wire carousel, 760mm	760x390x450mm	15 kg per shelf
WC270	3/4 Wire carousel, 700mm	800x800x700-750mm	20 kg per shelf

Note: Carcase sizes given are internal dimensions in width x depth x height



## 3/4 Carousel



### Wire Carousel Infinity Plus.

**Features:** Rotating system with 2 solid base baskets, 900x900mm corner base unit.

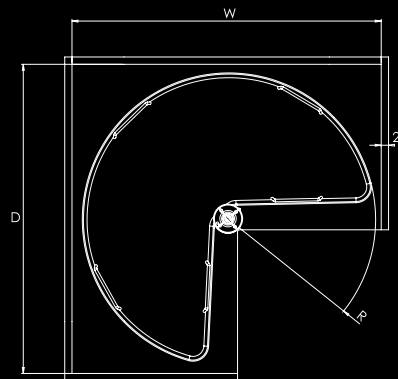

Code	Description	Min Carcase size	Loading
WC270PL	3/4 carousel	800x800x700mm	20kg

## 1/2 Carousel



### Wire Carousel Infinity Plus.

**Features:** Half-Moon solid base shelves for corner cabinet. 2 hand opening shelves.

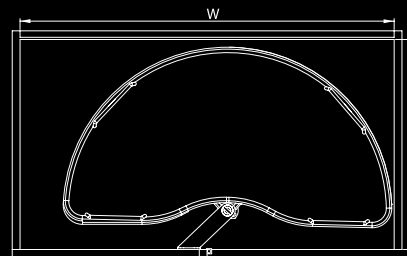

Code	Description	Min Carcase size	Loading
WC180PL	1/2 carousel	760x390x450mm	15kg

Note: Carcase sizes given are internal dimensions in width x depth x height



# Larder Unit Pullout Plus



**Features:** Soft Closing. Full extension.

**Options:** MFC solid base baskets.

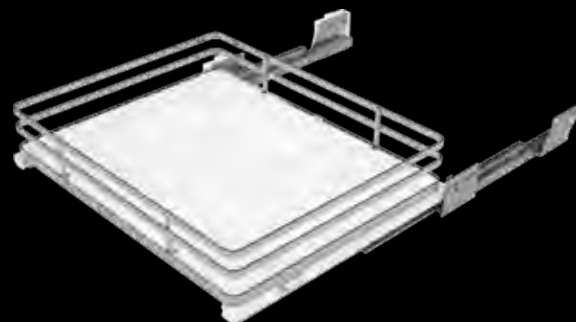

Code	Description	Min Carcase size	Loading
LD400CPL	400mm pull out basket, Silver/MFC Bottom baskets	400x455x1880-2175mm	30kg
LD450CPL	450mm pull out basket, Silver/MFC Bottom baskets	450x455x1880-2175mm	30kg
LD500CPL	500mm pull out basket, Silver/MFC Bottom baskets	500x455x1880-2175mm	30kg
LD600CPL	600mm pull out basket, Silver/MFC Bottom baskets	600x455x1880-2175mm	30kg

Note: Carcase sizes given are internal dimensions in width x depth x height





# Pan Drawer and Base Unit Pullouts

## Pan Drawer and Base Unit Pullout.

**Features:** Soft closing. Full extension.

**Options:** Chrome baskets.



Pan drawer pullout



Base unit pullout

Pan drawer pullout

Code	Description	Min Carcase size	Loading
PD300C	Pan drawer with full extension, 300mm	264x455mm	30kg
PD400C	Pan drawer with full extension, 400mm	364x455mm	30kg
PD500C	Pan drawer with full extension, 500mm	464x455mm	30kg
PD600C	Pan drawer with full extension, 600mm	564x455mm	30kg
BU300C	Base unit pullout with full extension, soft close, 300mm, chrome	264x455mm	30kg
BU400C	Base unit pullout with full extension, soft close, 400mm, chrome	364x455mm	30kg
BU500C	Base unit pullout with full extension, soft close, 500mm, chrome	464x455mm	30kg
BU600C	Base unit pullout with full extension, soft close, 600mm, chrome	564x455mm	30kg



Base unit pullout



# 150mm Wall Pullout Plus

## 150mm Wall Pullout

**Features:** Soft closing, full extension.

Code	Description	Min Carcase size	Loading
WP150PL	150mm, wall pullout, chrome	110x280x520mm	12kg



# 200mm Base Unit Plus



## Infinity Plus 200mm Base Unit Pullout

**Features:** Soft closing, full extension.

Code	Description	Min Carcase size	Loading
BP200PL	200mm, base pullout	160x450x520mm	30kg



Note: Carcase sizes given are internal dimensions in width x depth x height



# 150mm Base Unit

## 150mm Base Unit Pullout

**Features:** Soft-closing. Full extension.

**Options:** Chrome shelves, partitioned version, towel rail version.

Code	Description	Min Carcase size	Loading
BP150C	150mm, pullout, chrome	110x450x520mm	10kg
BP150DC	150mm, pullout with partitions, chrome	110x450x520mm	20kg
BP150TR	150mm, pullout with towel rail, chrome	110x450x520mm	20kg



# 150mm Base Unit Plus



## Infinity Plus 150mm Base Unit Pullout

**Features:** Soft-closing. Full extension.

Code	Description	Min Carcase size	Loading
BP150PL	150mm, pullout, chrome	110x450x520mm	20kg

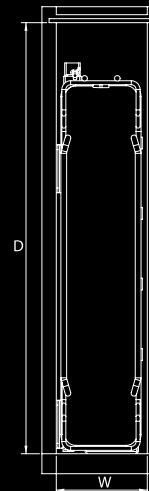

# Waste Bins

## Quadrifoglio Waste Bin.

**Features:** Soft closing. Full extension.

Code	Description	Min Carcase size	Loading
QUSBIN	Quadrifoglio, 600mm, under-sink bin	564x455x405mm	36 litres
QCB300	Quadrifoglio, 300mm, "cargo" bin	264x505x560mm	35 litres
QCB400	Quadrifoglio, 400mm, "cargo" bin	364x505x560mm	35 litres
QCB500	Quadrifoglio, 500mm, "cargo" bin	464x505x560mm	70 litres
QCB600	Quadrifoglio, 600mm, "cargo" bin	564x505x560mm	85 litres

Note: Carcase sizes given are internal dimensions in width x depth x height



QCB400



QCB500



QCB600



QCB300



QUSBIN



# Detergent Pullout

## Detergent Pullout

**Features:** Base pullout for undersink unit on soft close runner.  
Min unit width 450mm.



Code	Description	Min Carcase size	Loading
DP300	Detergent pullout,300mm	230x450x440mm	30kg
DP450	Detergent pullout,450mm	380x450x440mm	30kg

# Lockable Detergent Pullout

## Lockable Detergent Pullout

**Features:** Child proof lockable slide-out detergent basket.  
Ideal for undersink storage.



Code	Description	Min Carcase size	Loading
LDP300	Lockable detergent pullout,300mm	230x480x500mm	25kg

Note: Carcase sizes given are internal dimensions in width x depth x height



# Lighting



# A visionary company specialising in contemporary lighting

DOMUS Line is an Italian company that specialise in the design and development of innovative lighting products. They offer a portfolio which includes stylish and inspirational ideas. The synergy in the philosophies of both MAK and DOMUS Line allows the constant refinement of innovative products delivered at affordable price levels.

## Performance

An LED (“Light Emitting Diode”) has low energy consumption and high potential yield. Produced and built without interior filaments (which are more fragile and subject to rupture), or mobile parts, LEDs ensure a longer life and more dependability compared to other lamps.

The main advantages of LED technology:

- Use of LEDs allow very small light fittings
- Wide array of colour temperatures
- Long life
- Sturdiness
- Zero maintenance costs
- More lighting efficiency
- Clean light, because LEDs have no IR or UV components
- Safety, because LEDs are very low voltage
- Very small amount of heat generated (no risk of burns)

## Quality and Control

The development process of LED products is complex and delicate. It takes attentive quality controls to produce a fitting that complies with requirements. Therefore DOMUS Line has controls at each step of the production process in order to produce fittings with top quality and top performance.

- Selects the best LEDs on the market
- Designs optics in thermoplastic material
- Utilizes advanced technology for printed circuit boards
- DOMUS Line verifies the correct dissipation guaranteeing the respect of the imposed limits not only from the safety directives but also to guarantee the operative life of the LED
- Selects drivers to control the technical specifications of LEDs producers
- Offers highly functional accessories that create eclectic light direction, all the while respecting safety and visual comfort



DOMUS Line®

# Skate

- The new 'must have' of under cabinet lighting
- Innovative Touch LED dimming switch integrated
- Patented design by Bavuso Giuseppe
- 30% more light output compared to 20W of halogen

## SET SKATE TLDM 3X

with master Touch LED switch and converter

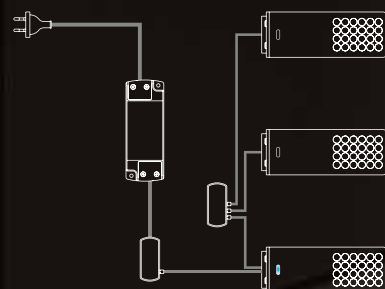

Code	Model	Watt & Volt	Light Colour	Finish
SKTD3XAL/NW	SET 3X	4.8W @ 240Vac	natural white	aluminium
SKTD3XSS/NW	SET 3X	4.8W @ 240Vac	natural white	steel

## SKATE Slave

without switch

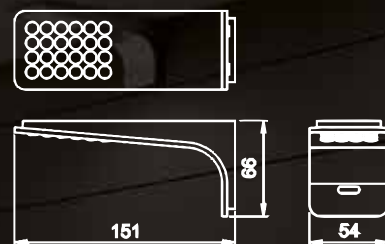

Code	Model	Watt & Volt	Light Colour	Finish
SKSLAL/NW	slave	1.6W @ 12Vdc	natural white	aluminium
SKSLSS/NW	slave	1.6W @ 12Vdc	natural white	steel

## Converters

Code	Model	Input	Output	Load
SL6/12	SL6/12	220 ÷ 240Vac	12Vdc	up to 3 SKATE
FLAT15/12	FLAT15/12	220 ÷ 240Vac	12Vdc	up to 9 SKATE
SL30/12	SL30/12	220 ÷ 240Vac	12Vdc	up to 12 SKATE





# Giza

- GIZA triangle LED light in High Quality Stainless Steel
- GIZA set with switch integrated

## GIZA V12

without switch

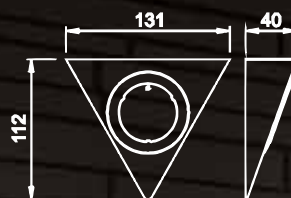

Code	Model	Watt & Volt	Light Colour	Finish
GIZ12SS/NW	12Vdc	1.6W @ 12Vdc	natural white	steel

## SET GIZA IG V12 3X

with on-off switch and converter

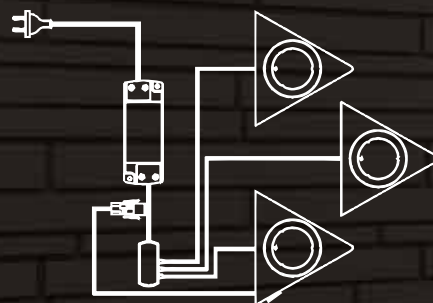

Code	Model	Watt & Volt	Light Colour	Finish
GIZ123XSS/NW	SET IG 3X	4.8W @ 240Vac	natural white	steel

## Converters

Code	Model	Input	Output	Load
SL6/12	SL6/12	220 ÷ 240Vac	12Vdc	up to 3 GIZA
FLAT15/12	FLAT15/12	220 ÷ 240Vac	12Vdc	up to 9 GIZA
SL30/12	SL30/12	220 ÷ 240Vac	12Vdc	up to 12 GIZA



# Metris

- 30% more light output compared to 20W of halogen
- Perfect as a substitute for halogen spotlights
- OB spacer for corner installations - No holes required
- SP spacer surface mounted - No holes required

## METRIS V12

for recessed installation on wood shelf



Code	Model	Watt & Volt	Light Colour	Finish
MTCH/NW	12Vdc	1.6W @ 12Vdc	natural white	chrome
MTAL/NW	12Vdc	1.6W @ 12Vdc	natural white	aluminium
MTSS/NW	12Vdc	1.6W @ 12Vdc	natural white	steel



## Converters

Code	Model	Input	Output	Load
SL6/12	SL6/12	220 ÷ 240Vac	12Vdc	up to 3 METRIS
FLAT15/12	FLAT15/12	220 ÷ 240Vac	12Vdc	up to 9 METRIS
SL30/12	SL30/12	220 ÷ 240Vac	12Vdc	up to 12 METRIS





Metris SP



Metris OB

### Spacer METRIS SP V12

for surface installation



Code	Model	Finish
MTSPCH	SP spacer	chrome
MTSPAL	SP spacer	aluminium
MTSPSS	SP spacer	steel

### Converters

Code	Model	Input	Output	Load
SL6/12	SL6/12	220 ÷ 240Vac	12Vdc	up to 3 METRIS
FLAT15/12	FLAT15/12	220 ÷ 240Vac	12Vdc	up to 9 METRIS
SL30/12	SL30/12	220 ÷ 240Vac	12Vdc	up to 12 METRIS

### Spacer METRIS OB V12

for surface installation

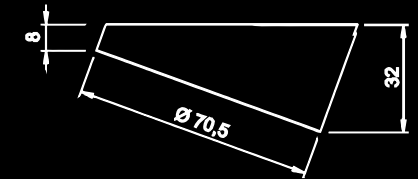

Code	Model	Finish
MTASPCH	OB spacer	chrome
MTASPAL	OB spacer	aluminium
MTASPSS	OB spacer	steel

### Converters

Code	Model	Input	Output	Load
SL6/12	SL6/12	220 ÷ 240Vac	12Vdc	up to 3 METRIS
FLAT15/12	FLAT15/12	220 ÷ 240Vac	12Vdc	up to 9 METRIS
SL30/12	SL30/12	220 ÷ 240Vac	12Vdc	up to 12 METRIS



# Leaf

- Elegant profile in extruded aluminium with asymmetrical light projection
- LEAF TLD Touch LED Dimming switch suitable for under wall cabinet
- LEAF DR sensor switch with plastic spacers to fit in drawers with side panels from 16mm to 19mm

## LEAF TLD

with Touch LED switch for under wall cabinet installation



Code	Length	Watt & Volt	Light Colour	Finish
LFTLD410/NW	410mm	1.44W @ 12Vdc	natural white	aluminium
LFTLD560/NW	560mm	2.16W @ 12Vdc	natural white	aluminium
LFTLD860/NW	860mm	3.60W @ 12Vdc	natural white	aluminium
LFTLD1160/NW	1160mm	5.04W @ 12Vdc	natural white	aluminium

## LEAF DR

with IR proximity sensor for pull-out drawers and basket drawers and basket drawers

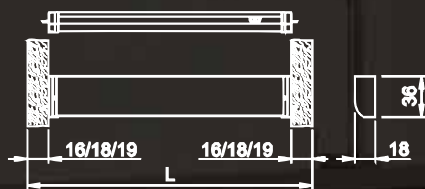

Code	Length	Watt & Volt	Light Colour	Finish
LFDR450/NW	450mm	1.68W @ 12Vdc	natural white	aluminium
LFDR600/NW	600mm	2.40W @ 12Vdc	natural white	aluminium
LFDR900/NW	900mm	3.84W @ 12Vdc	natural white	aluminium
LFDR1200/NW	1200mm	5.28W @ 12Vdc	natural white	aluminium

## Converters

Code	Model	Input	Output	Load
SL6/12	SL6/12	220 ÷ 240Vac	12Vdc	up to max. 6W for LEAF
FLAT15/12	FLAT15/12	220 ÷ 240Vac	12Vdc	up to max. 15W for LEAF
SL30/12	SL30/12	220 ÷ 240Vac	12Vdc	up to max. 30W for LEAF



Leaf DR

# Sunny

- SUNNY 3D IFR sensor switch natural white for inside cabinet

## SUNNY 3D IFR

with IFR presence sensor for inside cabinet installation



Code	Model	Watt & Volt	Light Colour	Finish
SN3D150/NW	IFR	3W @ 12Vdc	natural white	aluminium

## Converters

Code	Model	Input	Output	Load
SL6/12	SL6/12	220 ÷ 240Vac	12Vdc	up to max. 6W for SUNNY
FLAT15/12	FLAT15/12	220 ÷ 240Vac	12Vdc	up to max. 15W for SUNNY
SL30/12	SL30/12	220 ÷ 240Vac	12Vdc	up to max. 30W for SUNNY



# Twig

- Surface profile in extruded aluminium, easy to install
- TWIG TLD Touch LED dimming switch suitable for under wall cabinet

## TWIG TLD

with Touch LED switch for under wall cabinet installation

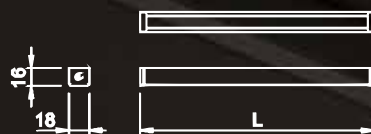

Code	Length	Watt & Volt	Light Colour	Finish
TWTLD410/NW	410mm	1.68W @ 12Vdc	natural white	aluminium
TWTLD560/NW	560mm	2.40W @ 12Vdc	natural white	aluminium
TWTLD860/NW	860mm	3.84W @ 12Vdc	natural white	aluminium
TWTLD1160/NW	1160mm	5.28W @ 12Vdc	natural white	aluminium

## Converters

Code	Model	Input	Output	Load
SL6/12	SL6/12	220 ÷ 240Vac	12Vdc	up to max. 6W for TWIG
FLAT15/12	FLAT15/12	220 ÷ 240Vac	12Vdc	up to max. 15W for TWIG
SL30/12	SL30/12	220 ÷ 240Vac	12Vdc	up to max. 30W for TWIG



# Diva

- Minimal design profile in extruded aluminium
- DIVA TLD Touch LED Dimming switch suitable for under wall cabinet installation

## DIVA TLD

with Touch LED switch for under wall cabinet installation



Code	Length	Watt & Volt	Light Colour	Finish
DVTLD376NW	376mm	1.44W @ 12Vdc	natural white	aluminium
DVTLD526NW	526mm	2.16W @ 12Vdc	natural white	aluminium
DVTLD826NW	826mm	3.60W @ 12Vdc	natural white	aluminium
DVTLD1126NW	1126mm	5.04W @ 12Vdc	natural white	aluminium

## Converters

Code	Model	Input	Output	Load
SL6/12	SL6/12	220 ÷ 240Vac	12Vdc	up to max. 6W for DIVA
FLAT15/12	FLAT15/12	220 ÷ 240Vac	12Vdc	up to max. 15W for DIVA
SL30/12	SL30/12	220 ÷ 240Vac	12Vdc	up to max. 30W for DIVA



FlexyLED CR/CH





- High Performance strip LED linkable in continuous row
- Connection between strips without dark areas - the distance between LEDs is always the same

- Comfortable natural white 4250-4600 Kelvin no blue shade
- Several lengths and can be cut every 50mm

## FlexyLED CR

continuous line installation



Code	Length	Watt & Volt	Light Colour	LEDs
FLEXY250CW	250mm	1.20W @ 12Vdc	natural white	15
FLEXY500CW	500mm	2.40W @ 12Vdc	natural white	30
FLEXY1000CW	1000mm	4.80W @ 12Vdc	natural white	60
FLEXY2000CW	2000mm	9.60W @ 12Vdc	natural white	120

## FlexyLED CH



Code	Length	Light Colour	LEDs
FLEXYCH5MCW	5m	natural white	60 LEDs per linear metre
FLEXYCH20MCW	20m	natural white	60 LEDs per linear metre



## Cables FlexyLED CR

Ref.	Code	Length	Model
A	FLEXPSC2000	2000mm	Power supply cable
B	FLEXYEXT1000	1000mm	Extension
B	FLEXYEXT2000	2000mm	Extension
C	FLEXYIC250	250mm	Interconnecting
C	FLEXYIC500	500mm	Interconnecting
C	FLEXYIC1000	1000mm	Interconnecting

## Cable FlexyLED CH

Code	Length	Model
FLEXYIC	-	Interconnector cable
FLEXYCHPSC2000	2000mm	Power supply cable
FLEXYCHIC5	50mm	Interconnector cable
FLEXYCHIC10	100mm	Interconnector cable

## FlexyLED CR Corner



Code	Length	Watt & Volt	T Colour	Finish	Model
FLEXYCNRCL	50x50mm	0.48W @ 12Vdc	natural white	white	L
FLEXYCNRCLR	50x50mm	0.48W @ 12Vdc	natural white	white	R

## Converters

Code	Model	Input	Output	Load
SL6/12	SL6/12	220 ÷ 240Vac	12Vdc	up to max. 6W for FlexyLED
FLAT15/12	FLAT15/12	220 ÷ 240Vac	12Vdc	up to max. 15W for FlexyLED
SL30/12	SL30/12	220 ÷ 240Vac	12Vdc	up to max. 30W for FlexyLED
SL60/12	SL60/12	220 ÷ 240Vac	12Vdc	up to max. 60W for FlexyLED



FlexyLED RGB



- LED RGB Technology with a colour changing electronic system
- Remote Controlled Unit which allows the desired colour and sequence to be selected

- Modules available in four standard lengths
- Easy to install and suitable for an infinity of applications

## FlexyLED RGB

continuous line installation

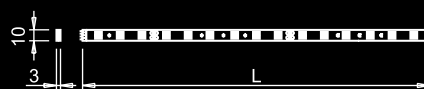

Code	Length	Watt & Volt	Light Colour	LEDs
FLEXY150RGB	150mm	1.20W @ 12Vdc	RGB	6
FLEXY300RGB	300mm	2.40W @ 12Vdc	RGB	12
FLEXY600RGB	600mm	4.50W @ 12Vdc	RGB	24
FLEXY1800RGB	1800mm	12.00W @ 12Vdc	RGB	72

## FlexyLED RGB Corner

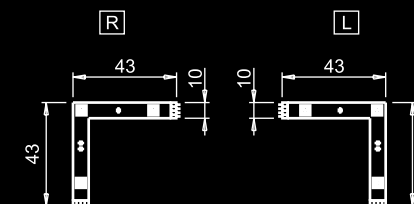

Code	Length	Watt & Volt	Light Colour	Model
FLEXYCNRRGBL	43x43mm	0.60W @ 12Vdc	RGB	L
FLEXYCNRRGBR	43x43mm	0.60W @ 12Vdc	RGB	R

## Cables FlexyLED RGB



Ref.	Code	Length	Model
A	FLEXPSC2000	2000mm	Power supply cable
B	FLEXYIC1000	1000mm	Interconnecting
B	FLEXYIC500	500mm	Interconnecting

## FlexyLED RGB Remote

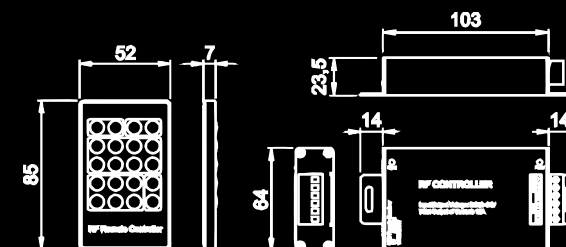

Code	Input	Output	Load
FLEXYRGBREM	12 ÷ 24Vdc	12 ÷ 24Vdc	144 ÷ 288W

## Converters

Code	Model	Input	Output	Load
SL30/12	SL30/12	220 ÷ 240Vac	12Vdc	up to 30W for FLEXYLED RGB
SL60/12	SL60/12	220 ÷ 240Vac	12Vdc	up to 60W for FLEXYLED RGB



# FlexyLED RGB

## Universal Installation

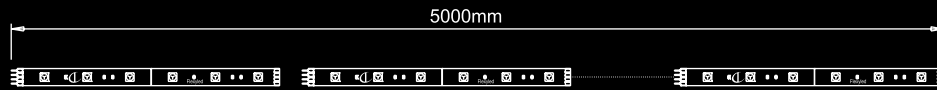

There are four modules equipped with micro connectors for the installation in a continuous line that can go up to 5000mm in length.



The 2000mm power cord is sold separately complete with a MultiPlug connector.

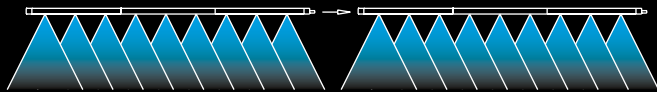

Thanks to the micro connectors, the continuous line connection does not have shadow areas because the distance between the LEDs is always the same.



The resin protects each LED strip against moderate mechanical shock and against water splashes (IP44 protection). The high degree of transparency and the circuit's high reflection varnished base offers professional light performance from the unit.



FLEXILED RGB can be easily divided every 75mm (3 LEDs). This lets you create any length with minimum waste.

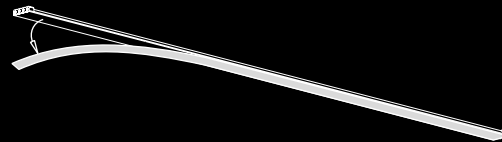

The highly resistant double sided adhesive provides fast installation without the use of any tools.

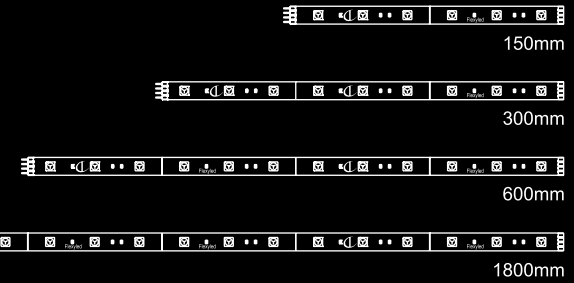

The 90° light angle lets you create complex systems but at the same time it lets you maintain the symmetry of the light flow even at the corners.

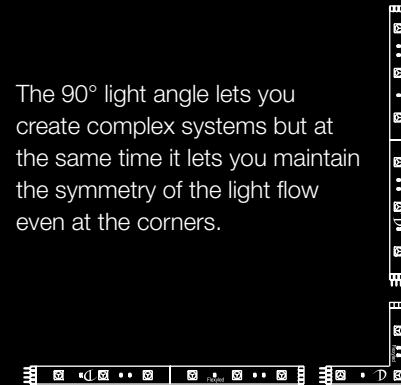

Inter-connection cables are also available for the remote connection of LED strips guaranteeing the electrical continuity.



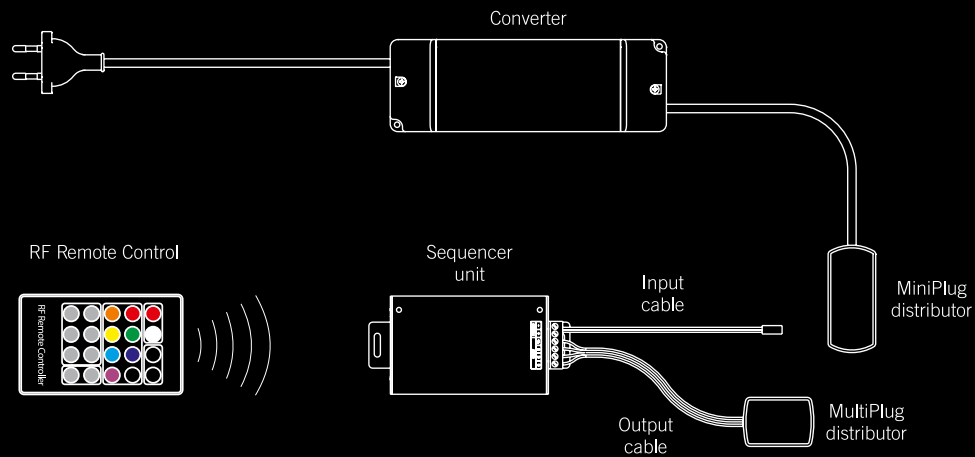
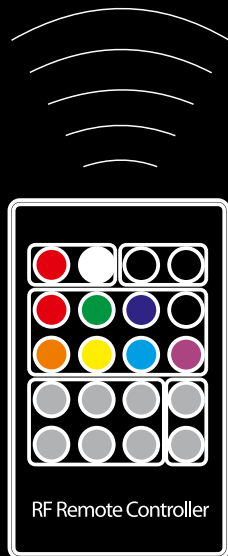

Button	Button Description	Comments
	ON/OFF	switching on – switching off
	play/stop	play or stop LED changing
	brightness increase	the brightness series will add once
	play/stop	the brightness series will reduce once
	static red	
	static green	
	static blue	
	static white	you can select the colour
	static orange	brightness is adjustable, speed is adjustable
	static yellow	
	static cyan	
	static purple	
	random	the colour changes continuously
	3 colour step change	speed and brightness are adjustable
	7 colour step change	speed and brightness are adjustable
	3 colour fade change	speed is adjustable brightness is unadjustable
	7 colour fade change	speed is adjustable brightness is unadjustable
	speed increase	the speed will add once
	speed decrease	the speed will reduce once
	seven colours flash	speed and brightness are adjustable

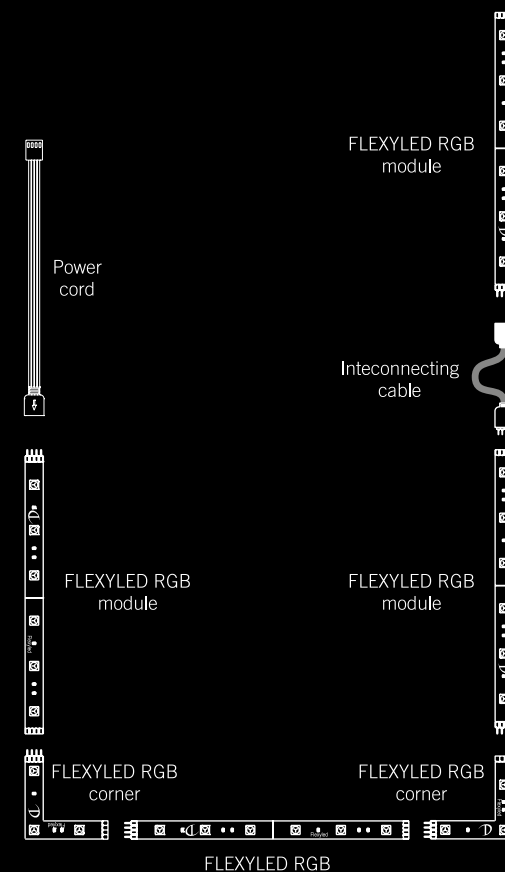

## FlexyLED CR Accessories

FlexyLED CR can be surface mounted or recessed, there are also four different profiles into which it's possible to integrate the LED strip.

- DIVA recessed profile in extruded aluminium
- TWIG surface profile in extruded aluminium

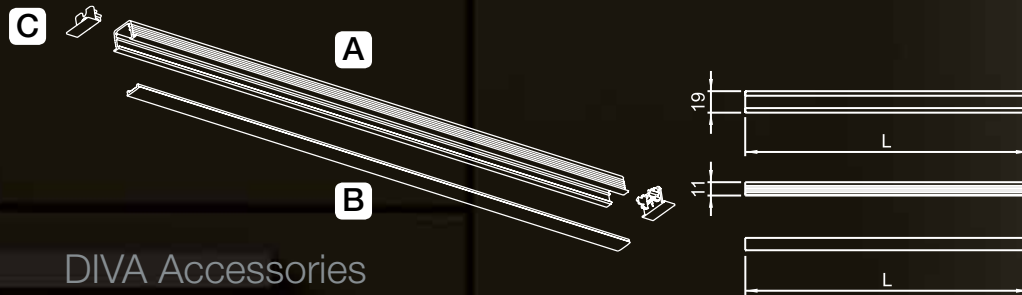

### DIVA Accessories

Aluminium profile and accessories for recessed installation

Code	Model	Length	Finish
DVAL2000	A – Aluminium profile	2000mm	Aluminium
DVSD2000	B – Plastic diffuser screen	2000mm	Opal White
DVECGY	C – 2 plastic end caps		Grey

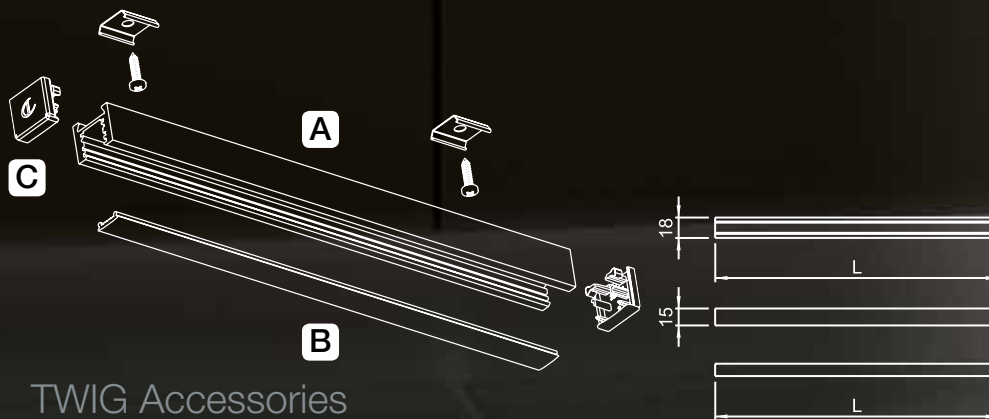

### TWIG Accessories

Aluminium profile and accessories for surface installation

Code	Model	Length	Finish
TWAL2000	A – Aluminium profile	2000mm	Aluminium
DVSD2000	B – Plastic diffuser screen	2000mm	Opal White
TWECGY	C – 2 plastic end caps		Grey



# Posh

- Minimal design suitable for any space requiring an accurate accent light
- Power LED cool white 5000-5700 Kelvin
- POSH HP trendy round spotlight giving high light output

## POSH HP

for recessed installation on wood shelf

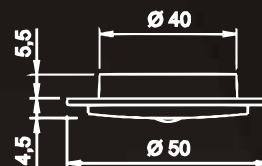

Code	Model	Watt & Volt	Light Colour	Finish
PSALCW	single	1.20W @ 350mA	cool white	aluminium
PSSSCW	single	1.20W @ 350mA	cool white	steel

## Converters

Code	Model	Input	Output	Load
SL6/350	SL6/350	220 ÷ 240Vac	350mA	up to 6 POSH
SL12/350	SL12/350	220 ÷ 240Vac	350mA	up to 10 POSH



# Pixel

- Elegant solution for any space requiring an accurate accent light
- Made in brass for a perfect finish
- OB spacer for surface installation - No hole required

## PIXEL V13

for recessed installation on wood shelf

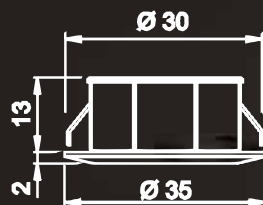

Code	Model	Watt & Volt	Light Colour	Finish
PXCHCW	single	1.20W @ 350mA	natural white	chrome
PXSSCW	single	1.20W @ 350mA	natural white	steel
PXALCW	single	1.20W @ 350mA	natural white	aluminium

## Spacer PIXEL OB

for surface installation



Code	Model	Finish
PXASPCH	OB spacer	chrome
PXASPNP	OB spacer	steel
PXASPAL	OB spacer	aluminium

## Converters

Code	Model	Input	Output	Load
SL6/350	SL6/350	220 ÷ 240Vac	350mA	up to 6 PIXEL
SL12/350	SL12/350	220 ÷ 240Vac	350mA	up to 10 PIXEL

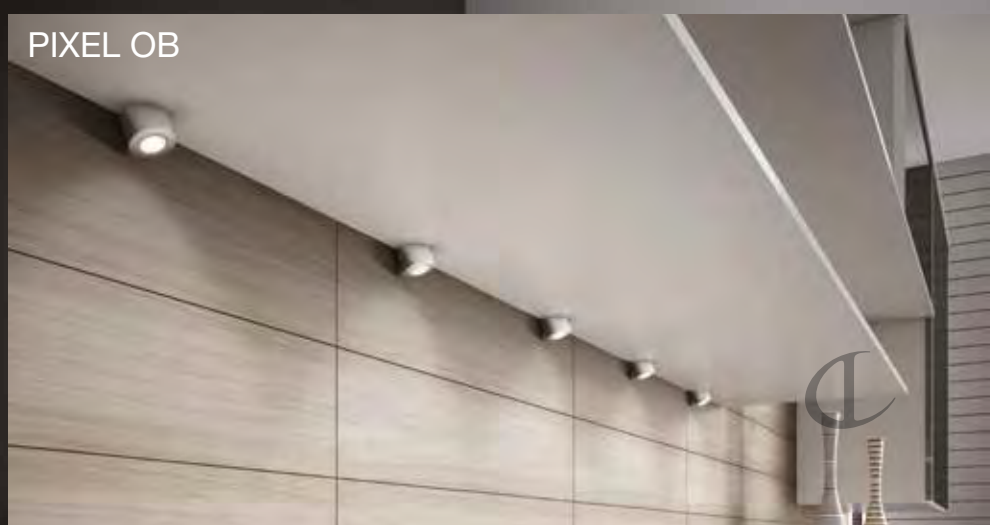



# Net

- Elegant solution for any space requiring an accurate accent light
- Made in brass for a perfect finish
- NET square design for modern furniture

## NET V13

for recessed installation on wood shelf

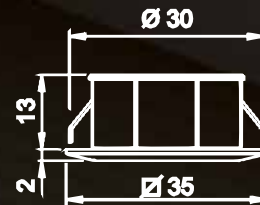

Code	Model	Watt & Volt	Light Colour	Finish
NTALCW	single	1.20W @ 350mA	natural white	aluminium

## Converters

Code	Model	Input	Output	Load
SL6/350	SL6/350	220 ÷ 240Vac	350mA	up to 6 NET
SL12/350	SL12/350	220 ÷ 240Vac	350mA	up to 10 NET

# Converter

## SL6/12



Code	Model	Input	Output	Load
SL6/12	SL6/12	220 ÷ 240Vac	12Vdc	0.5 ÷ 6W

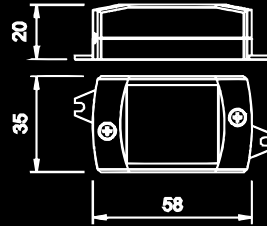
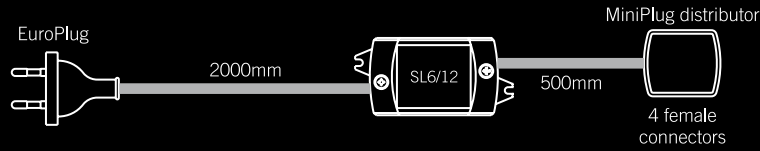

## FLAT15/12



Code	Model	Input	Output	Load
FLAT15/12	FLAT15/12	220 ÷ 240Vac	12Vdc	1 ÷ 15W

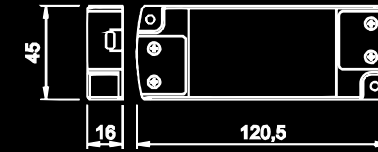
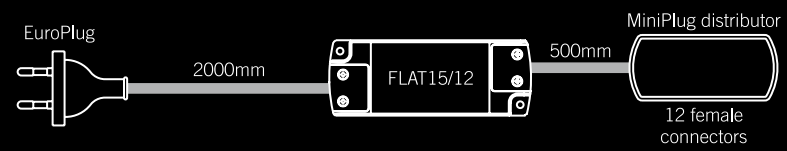

## SL30/12



Code	Model	Input	Output	Load
SL30/12	SL30/12	220 ÷ 240Vac	12Vdc	3 ÷ 30W

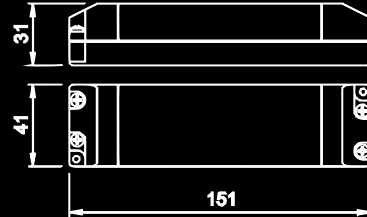
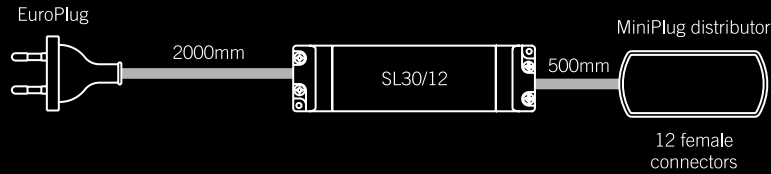

## SL6/350



Code	Model	Input	Output	Load
SL6/350	SL6/350	220 ÷ 240Vac	350mA	1 ÷ 6 LED

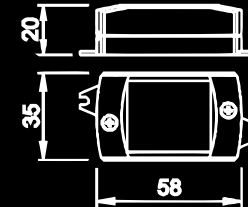
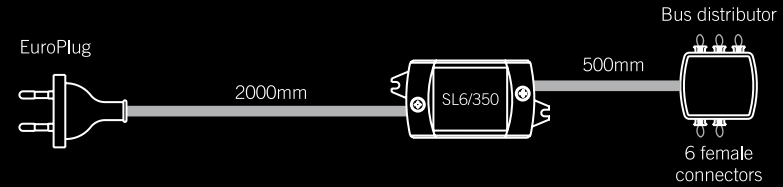

## SL12/350



Code	Model	Input	Output	Load
SL12/350	SL12/350	220 ÷ 240Vac	350mA	1 ÷ 10 LED

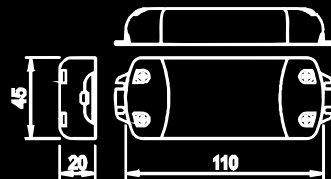
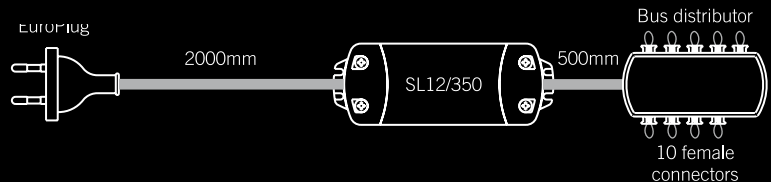

## SL30/24D, SL50/24D, SL75/24D



Code	Model	Input	Output	Load
SL30/24D	SL30/24D	220 ÷ 240Vac	24Vdc	up to max. 30W
SL50/24D	SL50/24D	220 ÷ 240Vac	24Vdc	up to max. 50W
SL75/24D	SL75/24D	220 ÷ 240Vac	24Vdc	up to max. 75W



## TLD V11

Touch LED switch



Code	Input	Output	Load	Finish
TLDV11	12 ÷ 24Vdc	12 ÷ 24Vdc	30÷ 60W	aluminium

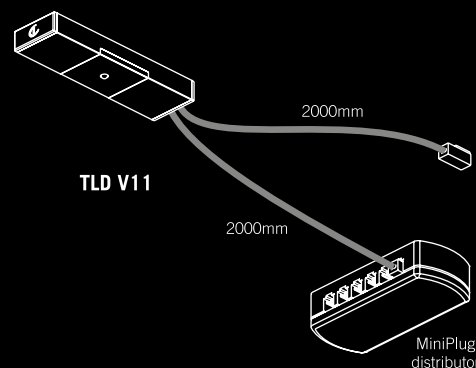
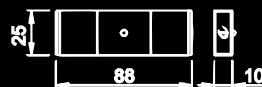

## TLD V12

Touch LED switch



Code	Input	Output	Load	Finish
TLDV12	12 ÷ 24Vdc	12 ÷ 24Vdc	30÷ 60W	aluminium

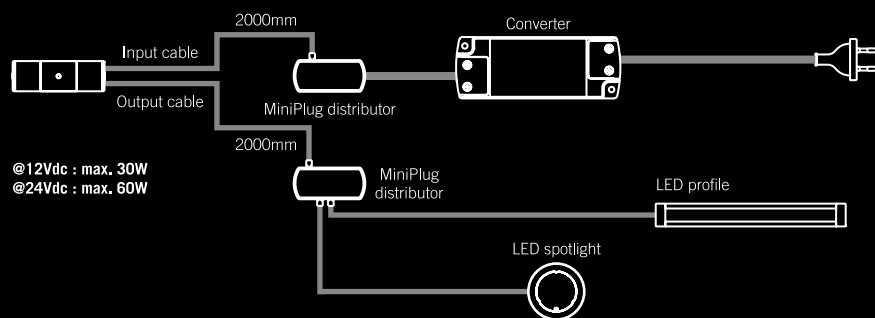
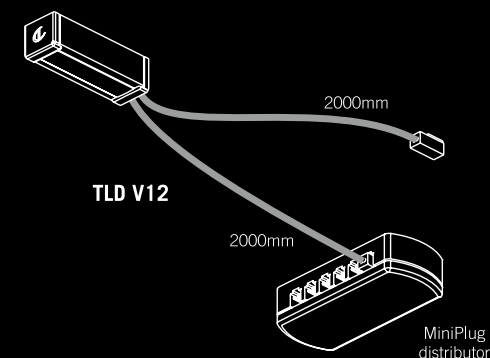
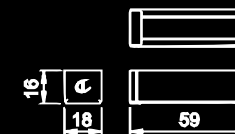

The switching on/off of the devices connected to the TLD is carried out with the simple rapid touch of the LED on the TLD. It is possible to adjust the intensity of the light (dimmer function) by maintaining the touch on the LED. A brief flash of the TLD indicates that maximum luminosity has been reached. The luminosity level will be memorized until the next adjustment (level memory). The TLD integrates the “night-light” function which activates only when the devices are switched off. With a high or sufficient level of light environment the TLD LED sends a soft light. With low or no light, the TLD is of a more intense light. During operation of the devices the emitted light by the TLD LED will be proportional to their adjustment.

The “night-light” function can be activated or deactivated by a 15 second touch after which, the deactivation of the function will be notified by 2 slow flashes, or its activation by 3 fast flashes. The TLD is fitted with a safety program that turns off the connected devices after 18 hours of continuous operation. Moreover TLD is endowed with function auto-on that allows the automatic turning on of the appliance as soon as it receives tension from the net through the feeder. The function has been designed for the automatic turning on of the appliance in particular in the show rooms at the daily activation of the electric switches without the necessity to act on every appliance.



# Sensor

## IFR V12

IFR presence sensor



Code	Input	Output	Load	Finish
IFRV12	220 ÷ 240Vac	12 ÷ 24Vac	24 ÷ 48W	aluminium

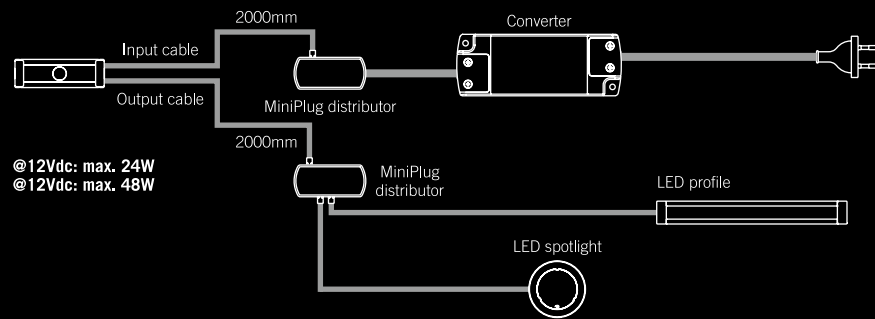
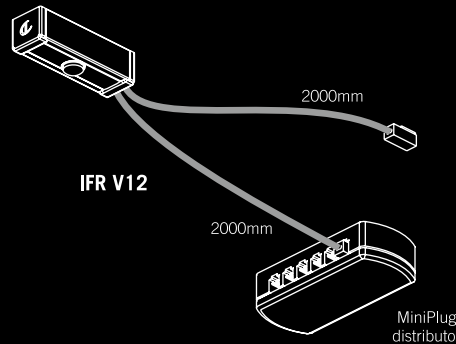
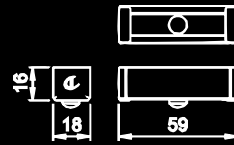

The switching on/off of the devices connected to the IFR is operated through the detection of temperature variations combined to the motion of people, animals and objects with a temperature of around 36°C within its detection range. In this condition the sensor IFR is activated, switching the connected devices on. The system remains active for the whole set time (30 seconds) after which, if no other motion is detected, it switches off automatically. The sensor must not be installed near electromagnetic sources, heat sources or exposed to direct sunlight.

## IFR V09

IFR presence sensor



Code	Input	Output	Load	Finish
IFRV09	220 ÷ 240Vac	12 ÷ 24Vac	150 ÷ 250W	white

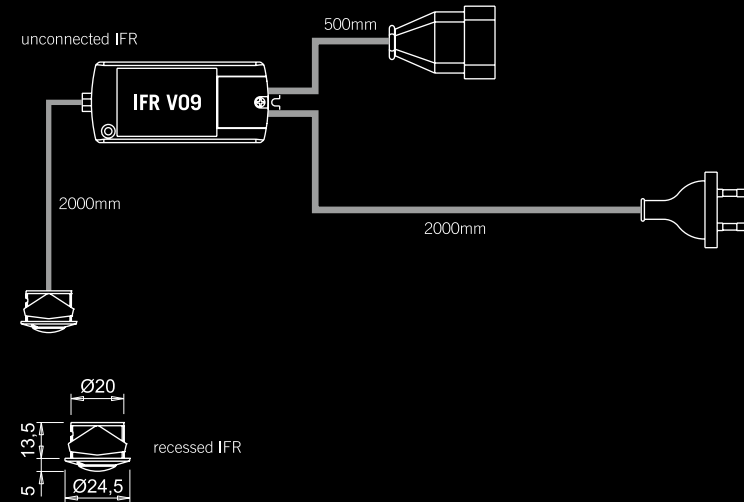
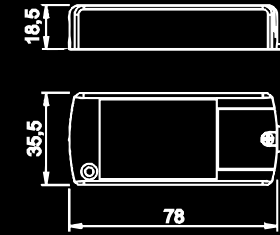

The switching on/off of the devices connected to the IFR is operated through the detection of temperature variations combined to the motion of people, animals and objects with a temperature of around 36°C within its detection range. In this condition the sensor IFR is activated, switching the connected devices on. The system remains active for the whole set time (adjustable between 10 seconds and 3 minutes) after which, if no other motion is detected, it switches off automatically. The sensor must not be installed near electromagnetic sources, heat sources or exposed to direct sunlight.



## Simply

Infrared proximity switch

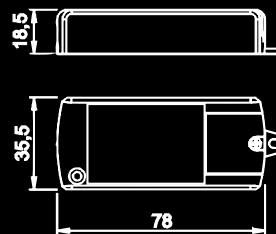

Code	Input	Output	Load	Finish
SSAL	220 ÷ 240ac	220 ÷ 240Vac	150 ÷ 250W	aluminium
SSWH	220 ÷ 240ac	220 ÷ 240Vac	150 ÷ 250W	white

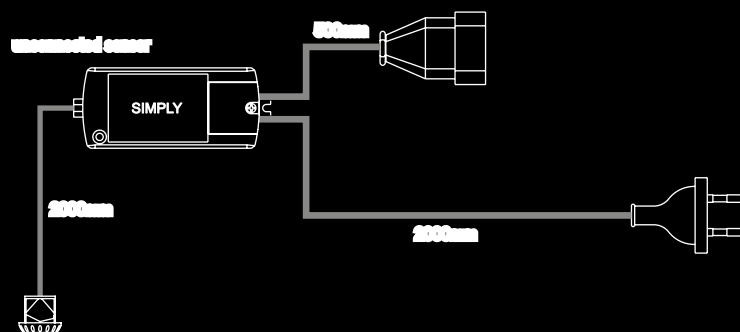

The activation of the device connected to SIMPLY is done by simply moving your hand less than 50mm from the sensor. The same operation, repeated once again, will switch the device off.

## Limit

Infrared limit switch

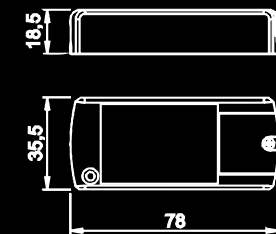

Code	Input	Output	Load	Finish
LSAL	220 ÷ 240ac	220 ÷ 240Vac	150 ÷ 250W	aluminium
LSWH	220 ÷ 240ac	220 ÷ 240Vac	150 ÷ 250W	white

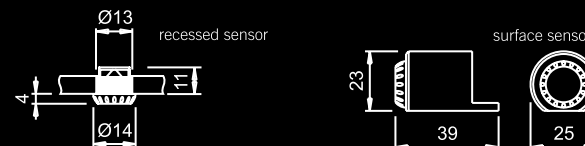
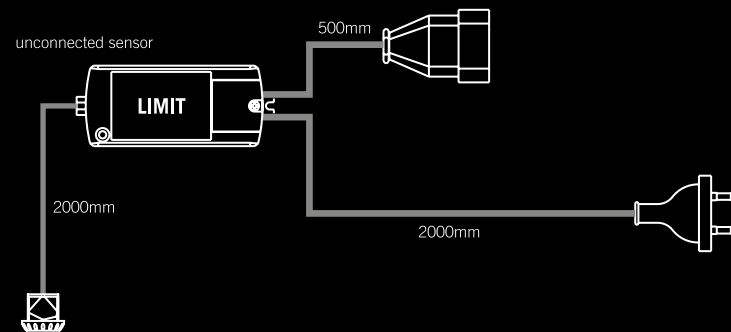

The switching on of the device connected to the LIMIT occurs when the sensor doesn't detect any object (e.g. one of the flaps) in front of itself (not higher than 50mm). The switching off is activated after the sensor detects a new object. For a perfect functioning of the LIMIT it's recommended to avoid the use of white, bright or reflecting surfaces.



# Carcases



## Features

- 38 different colour options available.
- Colour matched 2mm pvc lipping on all visible edges.
- All Carcasses are supplied with solid backs. 18mm on base units and 8mm on wall units.
- Made to order on a 7–10 working day delivery time (excluding holidays).
- Cam and dowel construction for easy assembly.
- All units supplied complete with Hettich Sensys 110' Integrated Self-Closing Hinges as standard \*
- Base units 560mm deep with 47mm service gap.
- 300mm and 330mm wall units available with 18mm service gap.
- Wall units supplied with Universal Adjustable Concealed Cabinet hangers.
- Drawer units supplied with Hettich Silver Innotech Soft-Closing Drawers complete with matching steel back.
- Base units supplied with 150mm adjustable legs.
- Special sizes and bespoke service available to order.
- Excellent Quality at highly competitive prices.

\* note that a 165° hinge with soft close option can be specified but these are chargeable as an extra item.



# Carcase colour matrix

## Egger options – woodgrain



**F501**  
Titanium



**W980WA**  
White Ash



**W1000**  
Premium Gloss White



**H1319**  
Light Calais Oak



**H1334**  
Light Ferrara Oak



**H1342**  
Montana Oak

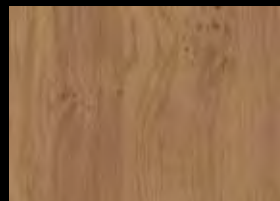

**H1381**  
Winchester Oak

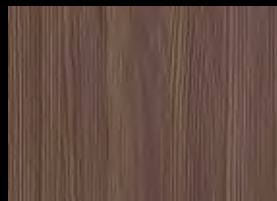

**H1484**  
Brown Grey Avola



**H3078**  
Hacienda White



**H3081**  
Hacienda Black



**H1521**  
Maple



**H1532**  
Pearwood



**H1582**  
Ellmau Beech



**H1727**  
Natural Birch



**H1731**  
Light Northumberland Birch



**H1869 (ST9)**  
Natural Canadian Maple

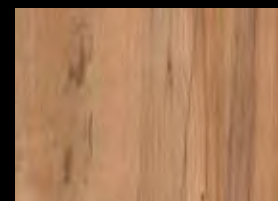

**H3700**  
Natural Pacific Walnut



**H3031**  
Dark Olive



**H3368**  
Natural Lancaster Oak

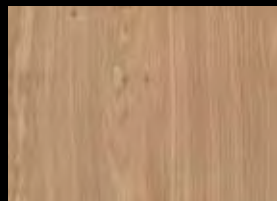

**H3382**  
Light Winchester Oak

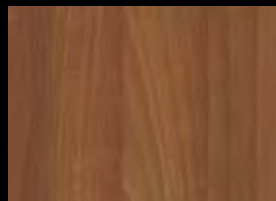

**H3703**  
Natural Aida Walnut

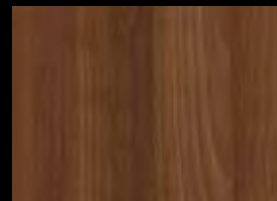

**H3704**  
Tobacco Walnut



**H3713**  
Matfen Cherry



# Egger options – uni-colour



For technical reasons connected with colour reproduction, colours shown may not be an exact representation of the actual product. Please ask for a sample before ordering.



# Hettich

The Hettich brand is synonymous throughout the world with quality, innovation and reliability.



# Sensys

Now there's a hinge where form and function are a perfect match: Sensys. Doors close silently, moved gently by an invisible force. With this exclusive self-closing function, plus integrated damping, Sensys delivers a luxury closing experience. Innovation at its best: award-winning design plus perfect functionality means Hettich can offer the perfect hinge with a full range of applications and plate options.

**Currently the only hinge technology available where all hinge options are available as soft-close**

- Integrated damping element
- Silence, design and emotion
- Door closes automatically from 35°

## Easy to fit

- Sensys is easy to fit and easy to adjust

## Clean and elegant looking

- Sensys has an elegant and contemporary look with simple and harmonious lines

Meets all customer expectations for outstanding design and quality

The Sensys hinge family includes products for all popular door mounting options. See price list for options.

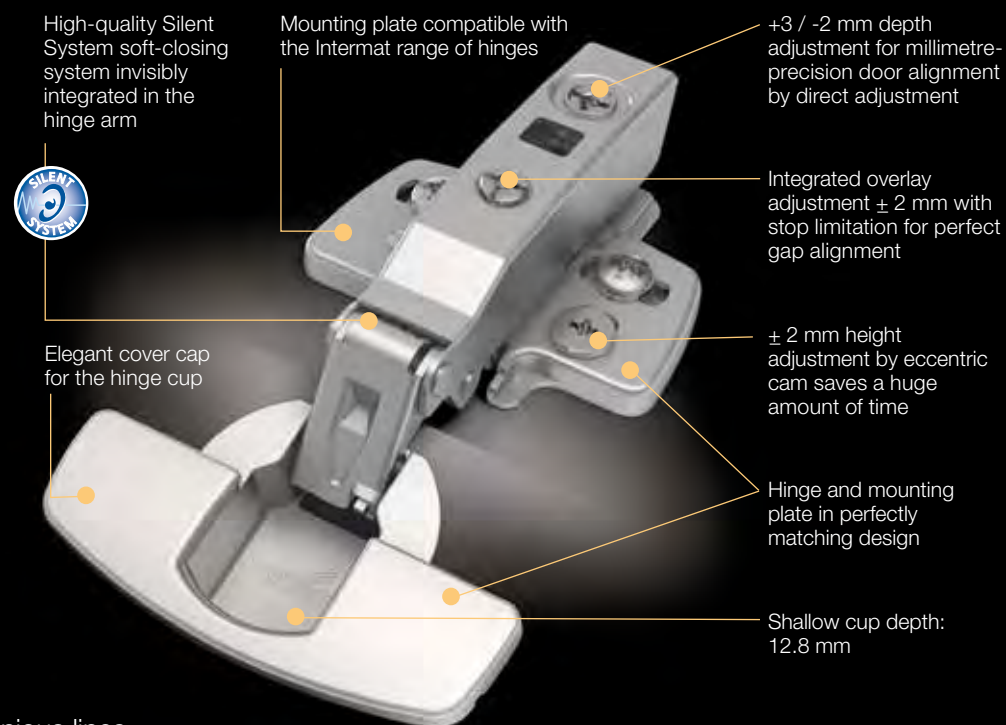

# InnoTech

Completing kitchen ranges at the right level of specification and quality. Giving the market genuine choice, whilst keeping production and inventory lean. This is the InnoTech drawer system. Numerous options, but just one drawer side panel. Flexibility meets efficiency.

## InnoTech Platform concept

- Economic mark of distinction

## 470mm Standard depth drawer system to maximise UK cabinet depths

- Also available in 260mm depth for dresser units

## Multi choice of widths available

- Steel rear panel in standard widths

## Multi choice of materials gives extra differentiation to customer

- Steel sides
- DesignSide, steel TopSide and railing available
- Drawer sides available in Silver as standard
- 4 options for pan drawers

## Multi choice of soft close runners available

- Integrated soft close
- 30 kg, 50 kg and 70 kg available from stock
- Stainless Steel ball bearings used for long life
- Runners tested to 80,000 open/close movements

## Durable, scratch resistant drawer sides

- Powder coating
- Smooth finish

## Easy to clean

- Ease of assembly and adjustment
- Rapid assembly to save time
- Thumbwheel adjustment of front panel height saves time when fitting
- Easy removal and re-connection of drawer fronts

## German engineering at its best

- Offering something that little bit different



Gallery Rail



Steel Sides



Clear Plastic Sides



Glass Sides



# InnoTech Drawer Accessories

## Innotech Internal Drawer Fronts.

- Available from 300mm-1200mm width
- Available in standard silver and frosted glass.

## Innotech Cutlery Tray

- Available from 300mm-1150mm width, silver

## Innotech Professional Cutlery Tray

- Available from 300mm-1200mm width, silver with dividing elements.
- Additional dividers available as an option

# Assembly aids for Innotech Drawer Systems



Drawer Marker



Drilling Jig for Hinges



Internal Drawer Fronts



Cutlery Tray for use with Innotech (not supplied with beech inserts)



Professional Cutlery Tray for use with Innotech (900mm version shown)

# InnoTech Drawer Accessories

## Orga Tray and Accessories

- Orga Tray, 600mm or 900mm width, silver
- Knife Holder, beech (knives not supplied)
- Spice Rack, beech, complete with 10 spice containers
- All items sold separately



## Orga Store

- Available in 900mm and 1000mm
- 2 Crosswise railing, 4 mounts, and dividing elements
- Pan drawer shown with clear plastic sides



## InnoTech Plate Holder

- Available in 900mm and 1000mm
- Supplied with 12 beech pins
- Extra pins available



Spice Rack  
and Spice Container



Knife  
Holder

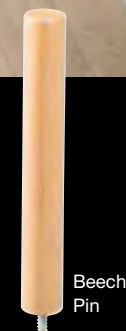

Beech  
Pin



## Carcase Adjustable Legs and Plinths Clips

- Adjustable height
- Manufactured using high quality thermoplastic resin resistant to humidity and high stress conditions
- Made in Italy!
- Max load 60KG
- Colour: Black
- For use on kitchen and general furniture units



Adjustable Leg



Plinth Clip



Socket

## Blum AVENTOS HK

AVENTOS HK components are easy to assemble. Once the lift mechanism has been precisely adjusted to the weight and size of the front, AVENTOS HK will open, close and hold with reliable ease. What's more, AVENTOS HK needs no hinges. Lever arms are closed so there are no projecting parts.

### AVENTOS HK – State-of-the-art stay lifts

International design juries have praised the visual result, and pros appreciate AVENTOS HK as a convenient lift system for mid wall units. The Aventos HK stay lift needs little space – even above fitted cabinets, e.g. above refrigerators.

### Programme

AVENTOS HK stands for a manageable programme and a wide range of planning options.

- Cabinet heights up to 600 mm
- Cabinet widths up to 1800 mm
- Can be used with cornice
- Use with any style of door
- Available in light, medium, heavy, and extra heavy duty depending on weight of door
- Lift mechanisms and front fixing brackets can be used symmetrically



## Easyfit Hinge System

The Easy Fit hinge is a system allowing a standard kitchen fascia to be installed over a freestanding washing machine, tumble dryer or similar appliance. Intended for a 647mm wide door fascia up to 22mm thick. Can be mounted left or right hand. White coated steel.

The East Fit hinge comes with full installation instructions. The Fittings pack contains:

- 1 x 6mm mild steel angle
- 2 x Face Frame Hinges
- 6 x combi screws (4x30)
- 2 x countersunk carcasse screws (4x 30)
- 1 x plastic stopper block





## Blum AVENTOS HF

### AVENTOS HF for Quality of Motion and Freedom of Design

AVENTOS HF is Blum's award winning fitting system for bi-fold fronts. The system provides endless possibilities in planning design with little installation effort. Aventos HF offers direct access, ease of use and freedom of movement.

- Suitable for cabinet 480 – 1040mm high and up to 1800mm wide.
- The Aventos HF is suitable for wooden and aluminium framed fronts
- Aventos HF is designed for quick and easy assembly – with just a few tools. The lift mechanism can be adjusted with a cordless screwdriver to achieve optimal function.
- Aventos HF will open, stop and close with reliable ease.

#### Parts required per Unit:

- 1 x Lift Mechanism Set.
- 1 x Lever Arm Set.
- 1 x Pair of front fixing brackets.
- 1 x cover cap set.

To Calculate the correct power factor multiply your cabinet height(mm) by the door weight including handles (KG)

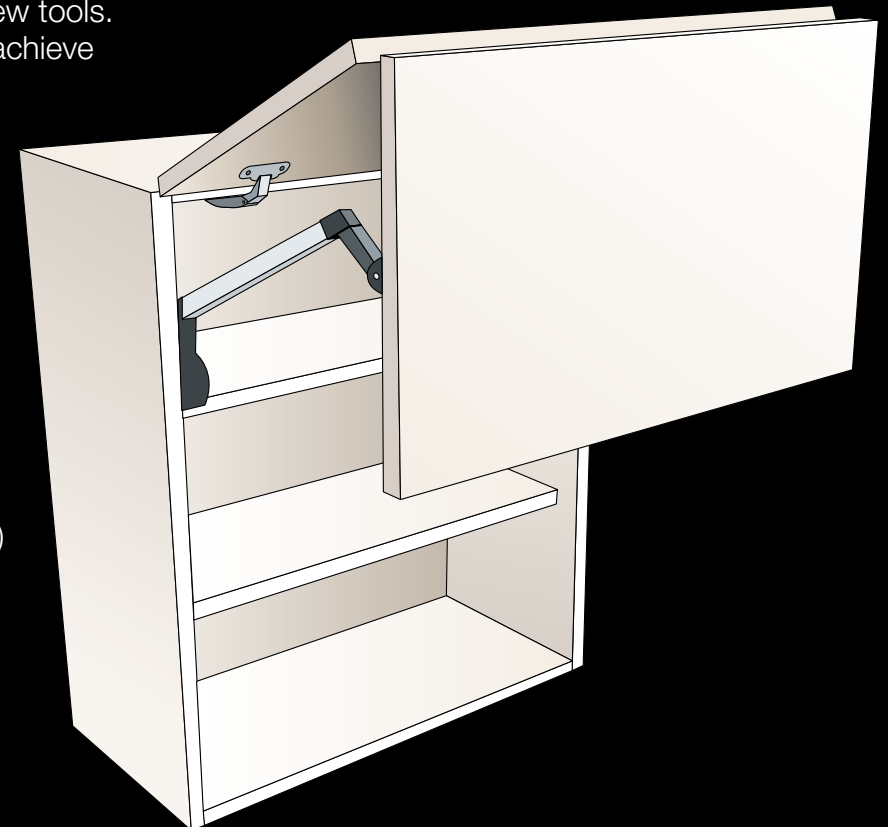

# Technical Information

## Base Units and Wall Units

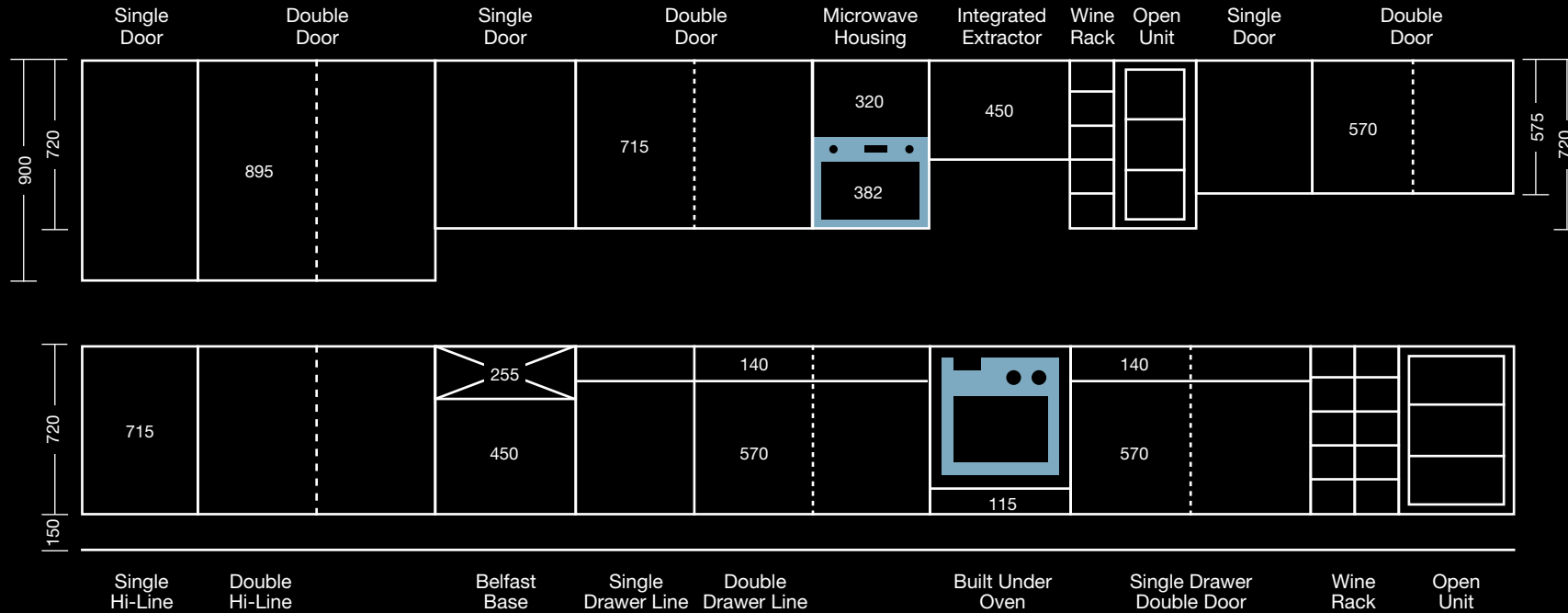

## Base Corner Units

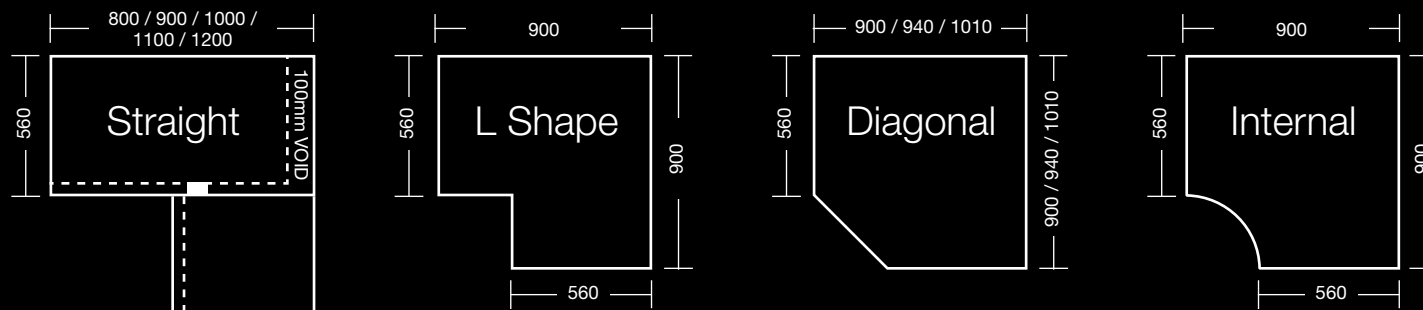

# Technical Information

## Drawer Packs and Feature Units

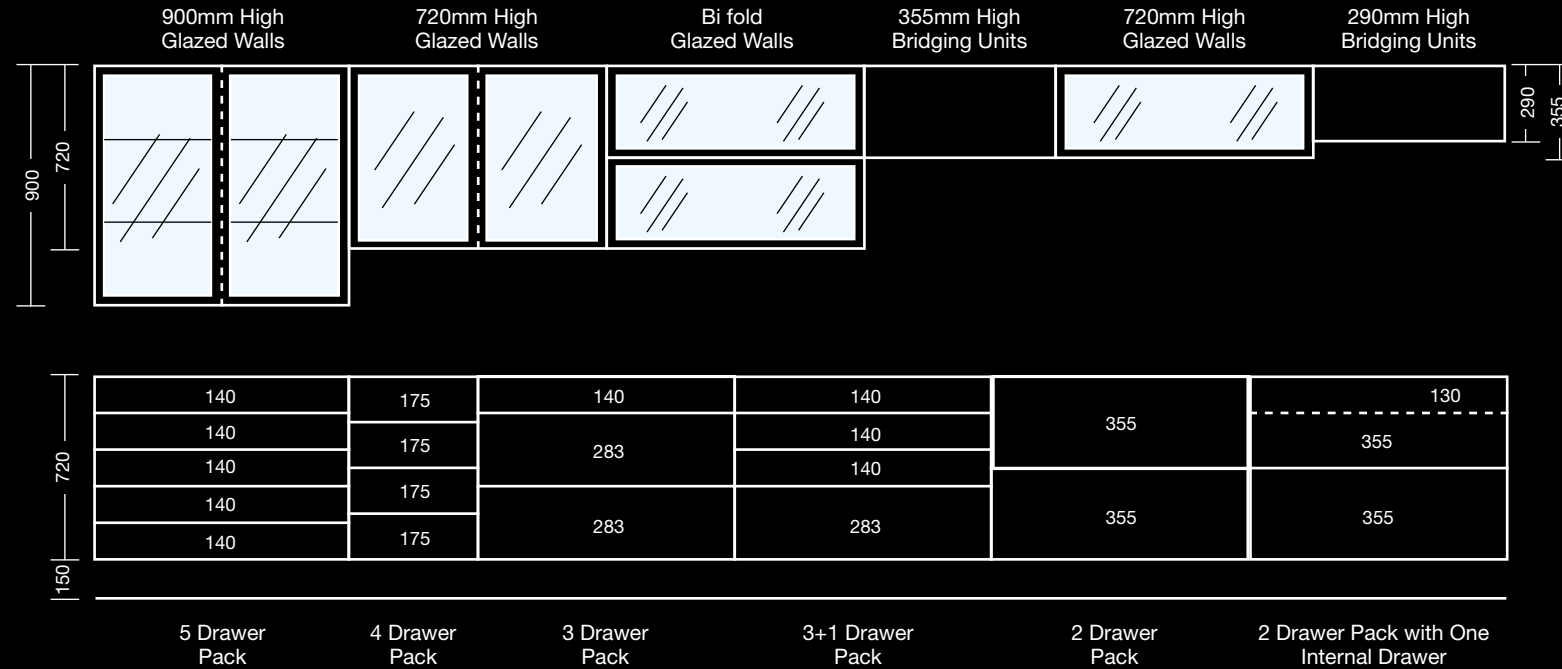

## Wall Corner Units

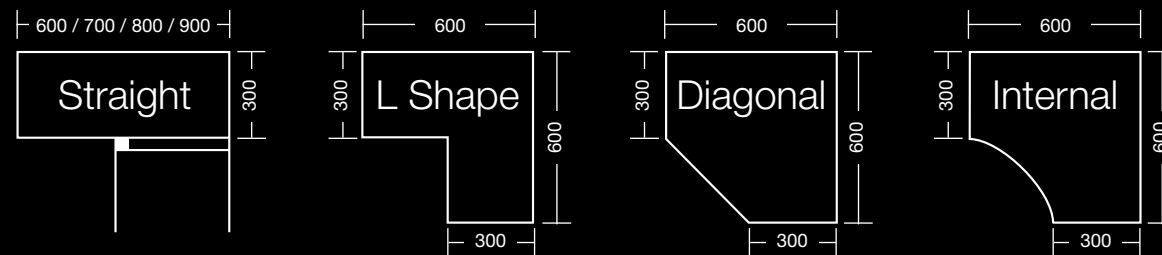

# Technical Information

## 1250mm Studio Height



## Angled Units

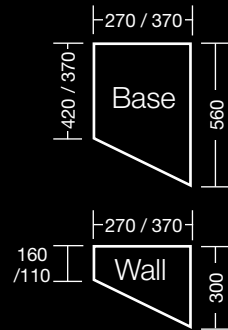

## Curved Units

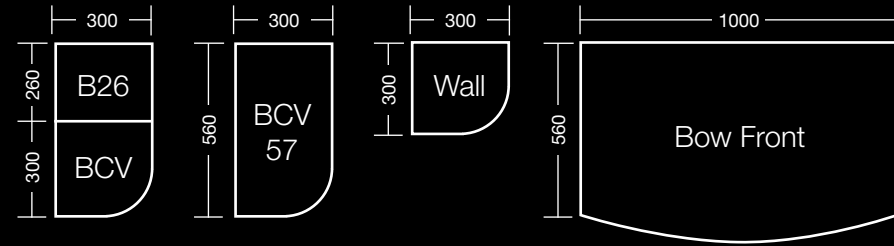

## 1970mm Tall Oven and Microwave Housings

Note: the overall guide height for wall unit installation is 2120mm

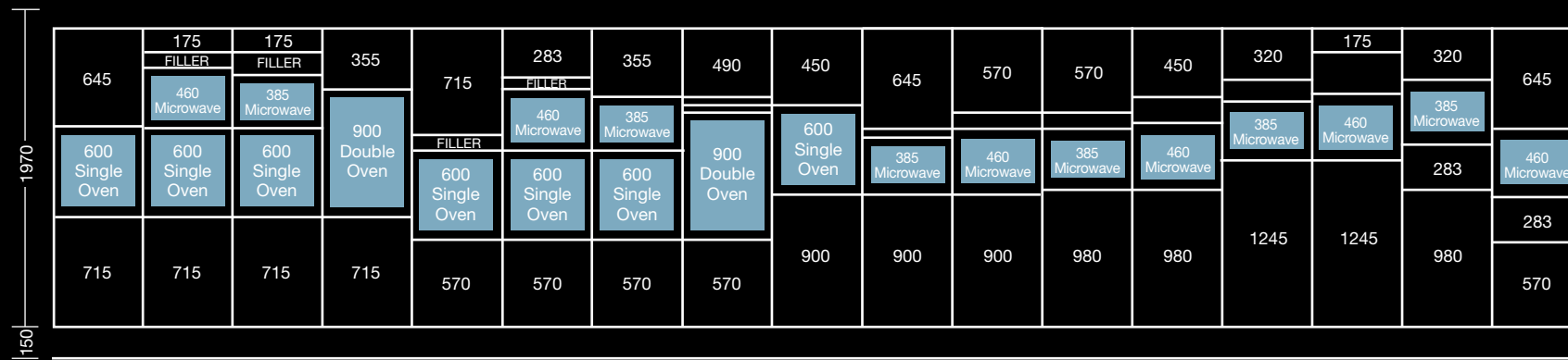

TAH60(B)

TAH60(D) TAH60(C) TAH60(A)

# Technical Information

## 2150mm Tall Oven and Microwave Housings

Note: the overall guide height for wall unit installation is 2300mm

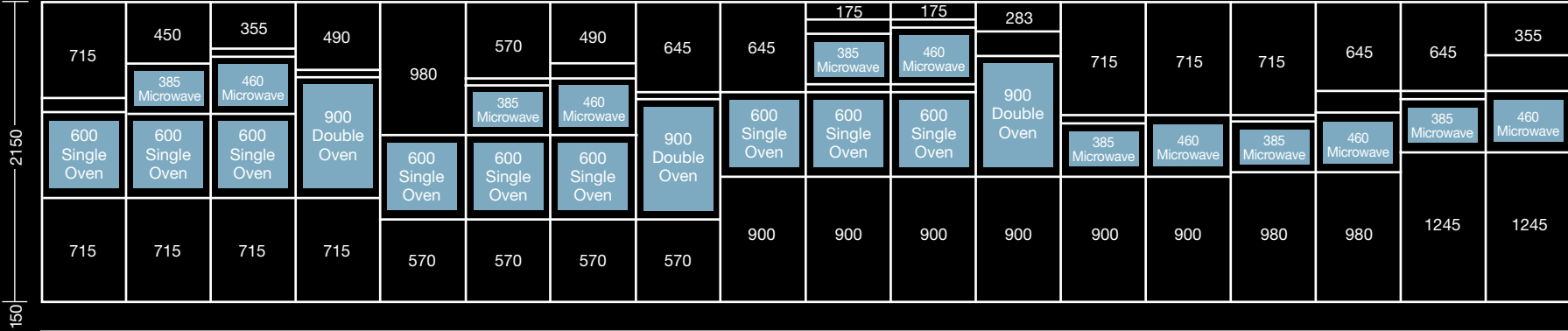

## 1970mm Tall Fridge and Freezer Housings

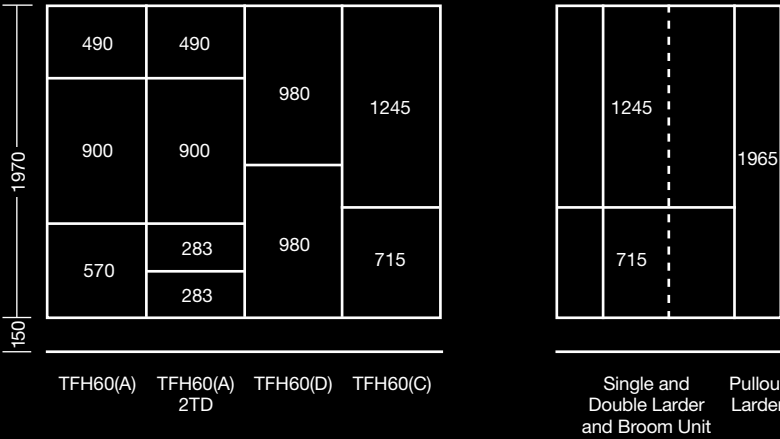

## 2150mm Tall Fridge and Freezer Housings

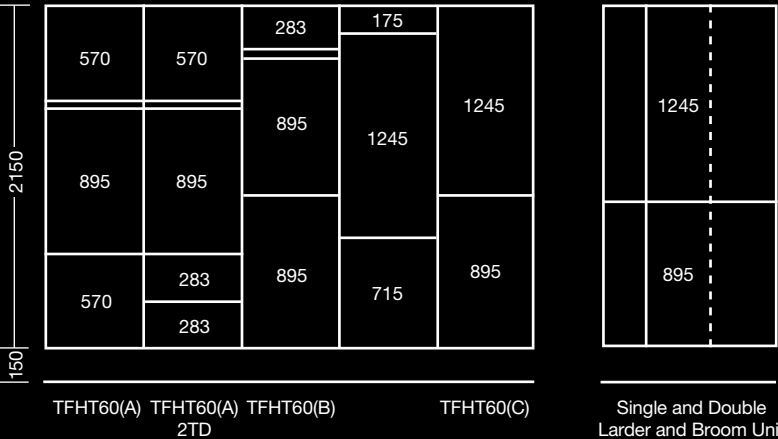

# Technical Information

## Lacquered Slab Door

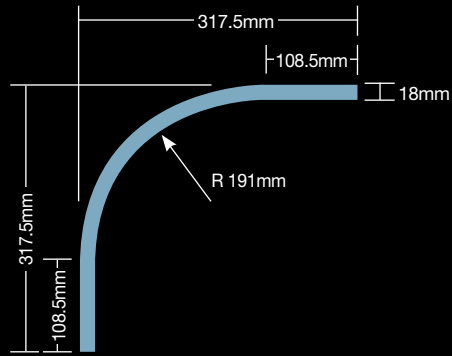

**Door height 715mm**

(895mm high door is also available in some ranges, please see price list)

## Timber Door

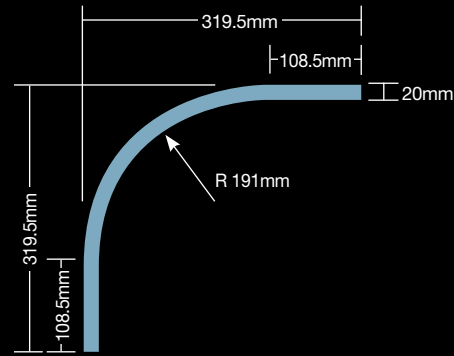

**Door height 715mm**

(895mm high door is also available in some ranges, please see price list)

## Jazi Internal Curve

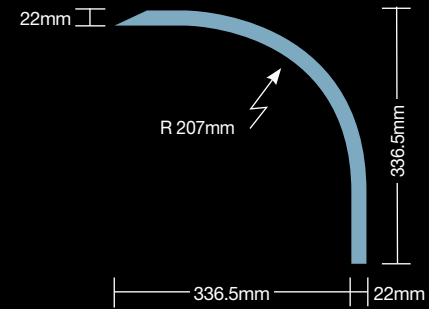

## 1000mm Curve

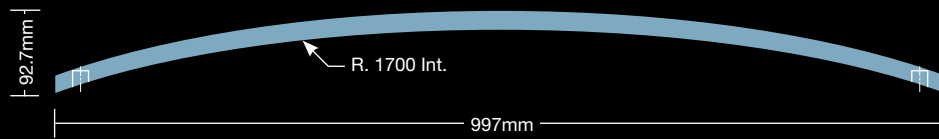

## Jazi External Curve

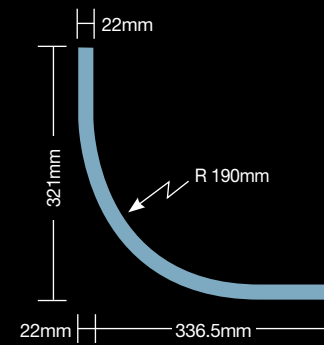

# Technical Information

## Bow Front Base Unit

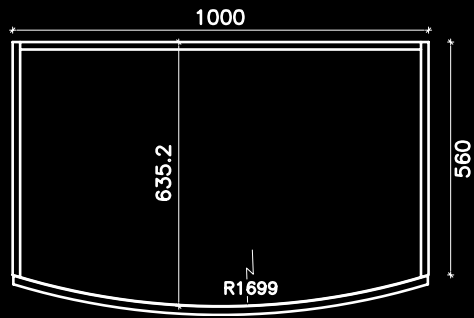

## External Wall Unit

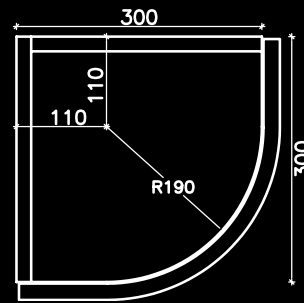

## External Base Unit

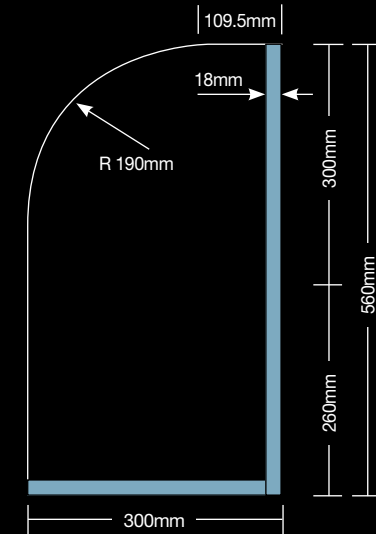

## Internal Base Unit

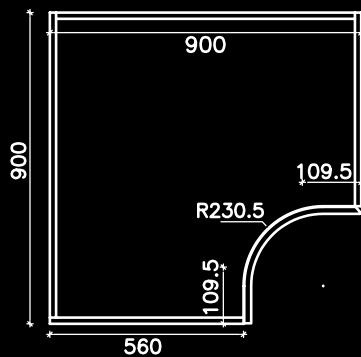

## Internal Wall Unit

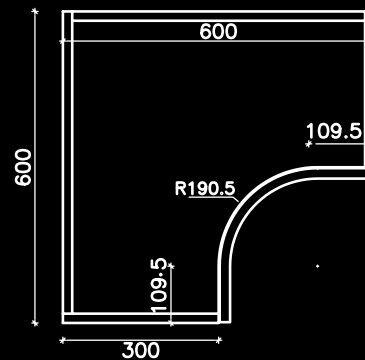

## Jazi Corner Solution

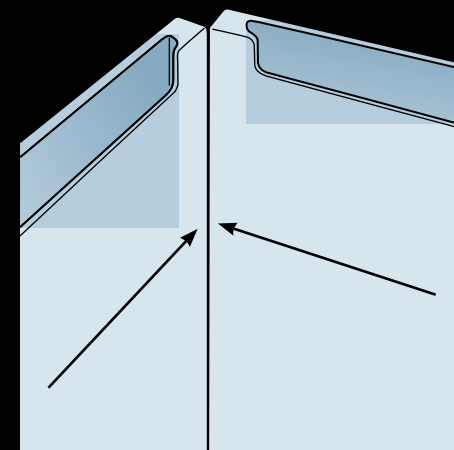

# Aperture Sizes

Prory frame

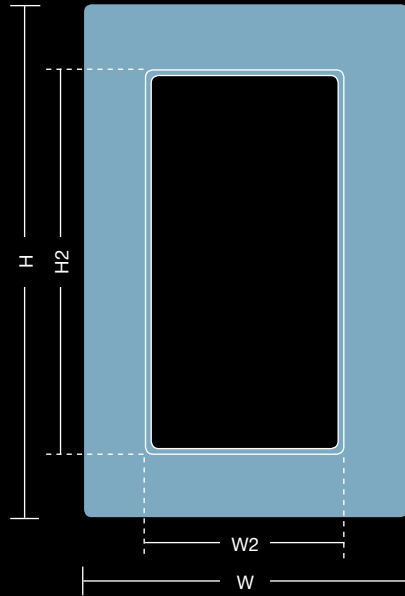

Door Height (H)	Door Width (W)	Aperture Height (H2)	Aperture Width (W2)
895mm	497mm	724mm	326mm
715mm	497mm	544mm	326mm
715mm	397mm	544mm	226mm
355mm	497mm	497mm	326mm

Urbani frame

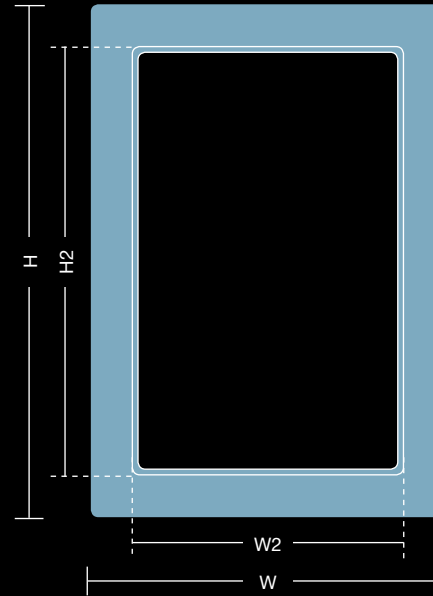

Door Height (H)	Door Width (W)	Aperture Height (H2)	Aperture Width (W2)
895mm	497mm	777mm	379mm
715mm	597mm	597mm	479mm
715mm	497mm	597mm	379mm
715mm	397mm	597mm	279mm
355mm	497mm	237mm	379mm

Jazi frame

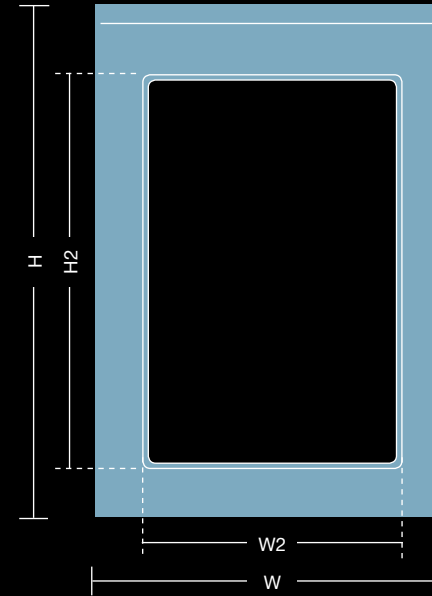

Door Height (H)	Door Width (W)	Aperture Height (H2)	Aperture Width (W2)
895mm	497mm	727mm	354mm
715mm	497mm	547mm	354mm
715mm	397mm	547mm	254mm
355mm	997mm	187mm	854mm
355mm	797mm	187mm	654mm
355mm	597mm	187mm	454mm
355mm	497mm	187mm	354mm



# Aperture Sizes

Westwood frame

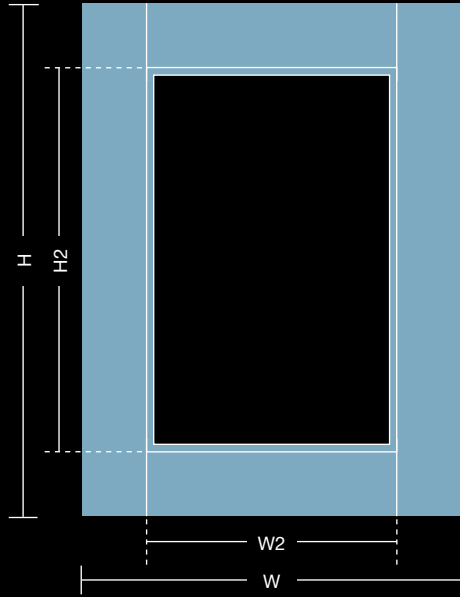

Door Height (H)	Door Width (W)	Aperture Height (H2)	Aperture Width (W2)
355mm	496mm	162mm	300mm
355mm	996mm	162mm	800mm
715mm	396mm	522mm	200mm
715mm	496mm	522mm	300mm
715mm	596mm	522mm	400mm
895mm	496mm	702mm	300mm
1065mm	496mm	872mm	300mm

Gainsborough frame

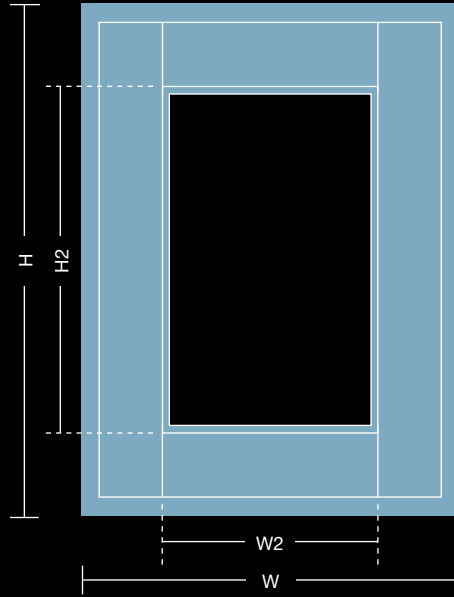

Door Height (H)	Door Width (W)	Aperture Height (H2)	Aperture Width (W2)
355mm	496mm	135mm	276mm
355mm	996mm	135mm	776mm
715mm	396mm	495mm	176mm
715mm	496mm	495mm	276mm
715mm	596mm	495mm	376mm
895mm	496mm	675mm	276mm
1065mm	496mm	845mm	276mm

Gainsborough frame with grille

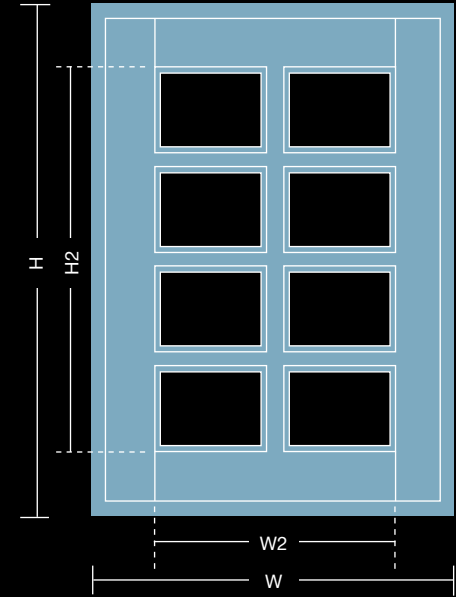

Door Height (H)	Door Width (W)	Aperture Height (H2)	Aperture Width (W2)
715mm	496mm	495mm	276mm
895mm	496mm	675mm	276mm
1065mm	496mm	845mm	276mm

715 x 496mm has a 3 x 2 grille.  
895 x 496mm and 1065 x 496mm have a 4 x 2 grille (as shown).



## Aperture Sizes

Glebe frame

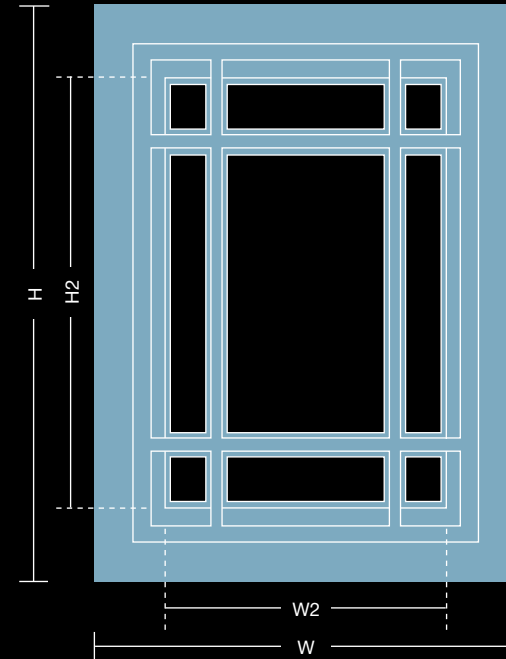

Door Height (H)	Door Width (W)	Aperture Height (H2)	Aperture Width (W2)
355mm	496mm	170mm	312mm
355mm	996mm	170mm	812mm
715mm	396mm	530mm	212mm
715mm	496mm	530mm	312mm
715mm	596mm	530mm	412mm
895mm	496mm	710mm	312mm
1065mm	496mm	880mm	312mm



## Jazi Silver Grey and Anthracite

Jazi Silver Grey and Anthracite. Worktop: Bianco Polished. Lighting Metris.

